

CONDENSING UNIT

*SXV9 AIR CONDITIONING INSTALLATION & SERVICE REFERENCE





INDEX

IMPORTANT SAFETY INSTRUCTIONS.....	1
SHIPPING INSPECTION.....	2
CODES & REGULATIONS.....	2
FEATURES.....	2
INSTALLATION CLEARANCES.....	3
ROOFTOP INSTALLATIONS.....	3
SAFE REFRIGERANT HANDLING.....	3
REFRIGERANT LINES.....	5
LEAK TESTING (NITROGEN OR NITROGEN-TRACED).....	7
SYSTEM START-UP PROCEDURE.....	8
ELECTRICAL CONNECTIONS.....	8
COOLCLOUD™ HVAC PHONE APPLICATION.....	11
COMFORTBRIDGE™ SYSTEM.....	13
AIR CONDITIONER ADVANCED FEATURE MENU.....	16
WIRING DIAGRAMS.....	18
TESTING CAPACITOR RESISTANCE.....	21
TROUBLESHOOTING.....	25
SETTING MODE DISPLAY.....	30
7-SEGMENT DISPLAY.....	36
START-UP CHECKLIST.....	39

IMPORTANT SAFETY INSTRUCTIONS

The following symbols and labels are used throughout this manual to indicate immediate or potential safety hazards. It is the owner's and installer's responsibility to read and comply with all safety information and instructions accompanying these symbols. Failure to heed safety information increases the risk of personal injury, property damage, and/or product damage.

Also see "Meanings of Symbols" on page 5.

	WARNING
<p>HIGH VOLTAGE DISCONNECT ALL POWER BEFORE SERVICING OR INSTALLING THIS UNIT. MULTIPLE POWER SOURCES MAY BE PRESENT. FAILURE TO DO SO MAY CAUSE PROPERTY DAMAGE, PERSONAL INJURY OR DEATH.</p>	
	

	WARNING
<p>ONLY PERSONNEL THAT HAVE BEEN TRAINED TO INSTALL, ADJUST, SERVICE OR REPAIR (HEREINAFTER, "SERVICE") THE EQUIPMENT SPECIFIED IN THIS MANUAL SHOULD SERVICE THE EQUIPMENT. THE MANUFACTURER WILL NOT BE RESPONSIBLE FOR ANY INJURY OR PROPERTY DAMAGE ARISING FROM IMPROPER SERVICE OR SERVICE PROCEDURES. IF YOU SERVICE THIS UNIT, YOU ASSUME RESPONSIBILITY FOR ANY INJURY OR PROPERTY DAMAGE WHICH MAY RESULT. IN ADDITION, IN JURISDICTIONS THAT REQUIRE ONE OR MORE LICENSES TO SERVICE THE EQUIPMENT SPECIFIED IN THIS MANUAL, ONLY LICENSED PERSONNEL SHOULD SERVICE THE EQUIPMENT. IMPROPER INSTALLATION, ADJUSTMENT, SERVICING OR REPAIR OF THE EQUIPMENT SPECIFIED IN THIS MANUAL, OR ATTEMPTING TO INSTALL, ADJUST, SERVICE OR REPAIR THE EQUIPMENT SPECIFIED IN THIS MANUAL WITHOUT PROPER TRAINING MAY RESULT IN PRODUCT DAMAGE, PROPERTY DAMAGE, PERSONAL INJURY OR DEATH.</p>	

	CAUTION
<p>DO NOT WASH THE CONDENSING UNIT WITH EXCESSIVE WATER. AN ELECTRIC SHOCK OR FIRE COULD RESULT.</p>	

	WARNING
<p>DO NOT BYPASS SAFETY DEVICES</p>	



"Proper sizing and installation of equipment is critical to achieve optimal performance. Split system air conditioners and heat pumps must be matched with appropriate coil components to meet ENERGY STAR criteria. Ask your contractor for details or visit www.energystar.gov.

IMPORTANT – This product has been designed and manufactured to meet ENERGY STAR criteria for energy efficiency when matched with appropriate coil components. However, proper refrigerant charge and proper air flow are critical to achieve rated capacity and efficiency. Installation of this product should follow the manufacturer's refrigerant charging and air flow instructions. **Failure to confirm proper charge and airflow may reduce energy efficiency and shorten equipment life."**

19001 Kermier Rd. Waller, TX 77484
www.goodmanmfg.com • www.amana-hac.com

© 2022 **DAIKIN COMFORT TECHNOLOGIES MANUFACTURING, L.P.**
Amana is a registered trademark of Maytag Corporation or its related companies and is used under license. All rights reserved.





CAUTION

THIS APPLIANCE IS NOT TO BE USED BY PERSONS (INCLUDING CHILDREN) WITH REDUCED PHYSICAL, SENSORY OR MENTAL CAPABILITIES, OR LACK OF EXPERIENCE AND KNOWLEDGE, UNLESS THEY HAVE BEEN GIVEN SUPERVISION OR INSTRUCTION.



CAUTION

CHILDREN SHOULD NOT PLAY WITH THIS APPLIANCE.



CAUTION

THE UNIT HAS ITS OWN PUMP-DOWN MODE. USE THE PUMP-DOWN MODE WHILE VACUUMING THE UNIT. VACUUMING TOO LOW CAN CAUSE INTERNAL ELECTRICAL ARCING, RESULTING IN A DAMAGED OR FAILED COMPRESSOR.

SHIPPING INSPECTION

Always keep the unit upright; laying the unit on its side or top may cause equipment damage. Shipping damage, and subsequent investigation is the responsibility of the carrier. Verify the model number, specifications, electrical characteristics, and accessories are correct prior to installation. The distributor or manufacturer will not accept claims from dealers for transportation damage or installation of incorrectly shipped units.

CODES & REGULATIONS

This product is designed and manufactured to comply with national codes. Installation in accordance with such codes and/or prevailing local codes/regulations is the responsibility of the installer. The manufacturer assumes no responsibility for equipment installed in violation of any codes or regulations. Rated performance is achieved after 20 hours of operation. Rated performance is delivered at the specified airflow. See outdoor unit specification sheet for split system models or product specification sheet for packaged and light commercial models. Specification sheets can be found at www.goodmanmfg.com for Goodman® brand products or www.amana-hac.com for Amana® brand products. Within the website, please select the residential or commercial products menu and then select the submenu for the type of product to be installed, such as air conditioners or heat pumps, to access a list of product pages that each contain links to that model's specification sheet.

The United States Environmental Protection Agency (EPA) has issued various regulations regarding the introduction and disposal of refrigerants. Failure to follow these regulations may harm the environment and can lead to the imposition of substantial fines. Should you have any questions please contact the local office of the EPA.

If replacing a condensing unit, heat pump or air handler, the system must be manufacturer approved and Air Conditioning, Heating and Refrigeration Institute (AHRI) matched.

NOTE: THE INSTALLATION OF AN INVERTER CONDENSING UNIT WITH UNMATCHED SYSTEM UNITS WILL NOT ALLOW FOR PROPER OPERATION.

NOTICE

INVERTER AIR CONDITIONING MODELS CAN ONLY BE MATCHED WITH EITHER AN AVPEC** / AMVE** AIR HANDLER OR COIL WITH TXV-V** EXPANSION VALVE KIT. DAMAGE RESULTING FROM OPERATION WITH ANY OTHER COMBINATION IS NOT COVERED BY OUR WARRANTIES.

Outdoor inverter units are approved for operation above 0°F in cooling mode with no additional kit necessary.

Damage resulting from operation of the units in a structure that is not complete (either as part of new construction or renovation) is not covered by our warranties.

FEATURES

This air conditioner is part of a ComfortBridge™ control system that uses inverter technology to more efficiently control heat gain/loss with better efficiency and achieve targeted comfort conditions.

The system utilizes digital communication between the indoor and outdoor equipment and can be controlled by any single-stage thermostat.

The ComfortBridge control system reduces the number of required thermostat wires, provides additional setup features and enhanced diagnostics through Bluetooth connectivity with the CoolCloud™ app.

Due to components using inverter technology, the air conditioner will not function properly if used with a non-approved control system.



NOTICE

APPROVED SYSTEMS ARE COMBINATION OF COMFORTBRIDGE COMPATIBLE INDOOR UNIT AND SINGLE-STAGE THERMOSTAT (WITH DEHUMIDIFICATION FUNCTION).

INSTALLATION CLEARANCES

Special consideration must be given to location of the condensing unit(s) in regard to structures, obstructions, other units, and any/all other factors that may interfere with air circulation. Where possible, the top of the unit should be completely unobstructed; however, if vertical conditions require placement beneath an obstruction **there should be a minimum of 60 inches between the top of the unit and the obstruction(s)**. The specified dimensions meet requirements for air circulation only. Consult all appropriate regulatory codes prior to determining final clearances.

Another important consideration in selecting a location for the unit(s) is the angle to obstructions. Either side adjacent the valves can be placed toward the structure provided the side away from the structure maintains minimum service clearance. Corner installations are strongly discouraged.

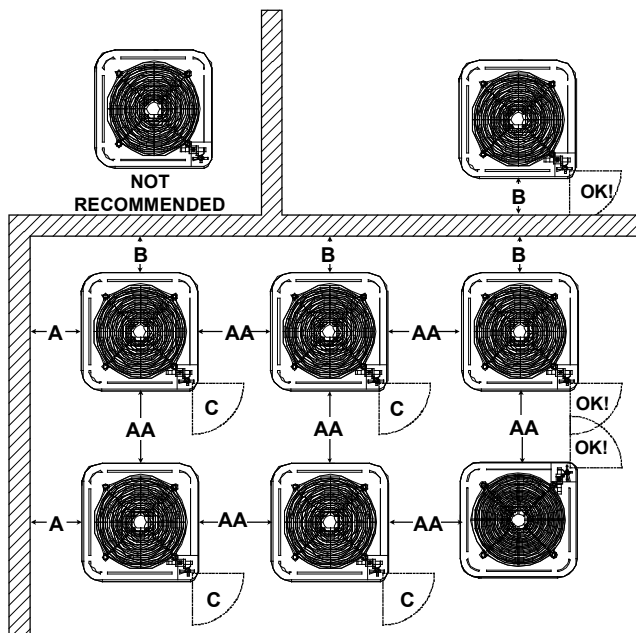

Minimum Airflow Clearance				
Model Type	A	B	C	AA
Residential	10"	10"	18"	20"
Light Commercial	12"	12"	18"	24"

This unit can be located at ground floor level or on flat roofs. At ground floor level, the unit must be on a solid, level foundation that will not shift or settle. To reduce the possibility of sound transmission, the foundation slab should not be in contact with or be an integral part of the building foundation. Care should be taken to ensure the unit is installed away from noise sensitive locations such as bedrooms, windows and outdoor living areas. Ensure the foundation is sufficient to support the unit. A concrete slab raised above ground level provides a suitable base.

ROOFTOP INSTALLATIONS

If it is necessary to install this unit on a roof structure, ensure the roof structure can support the weight and that proper consideration is given to the weather-tight integrity of the roof. Since the unit can vibrate during operation, sound vibration transmission should be considered when installing the unit. Vibration absorbing pads or springs can be installed between the condensing unit legs or frame and the roof mounting assembly to reduce noise vibration.

ELECTRICAL NOISE

The unit should be well grounded so that potential effects of electrical noise from the inverter to surrounding equipment can be minimized.

When selecting an installation location, keep sufficient distance from the air conditioner unit and wiring to radios, personal computers, stereos, etc., as shown in the following figure.

Keep communication wiring 2" away from high voltage over cable to avoid communication error due to noise.

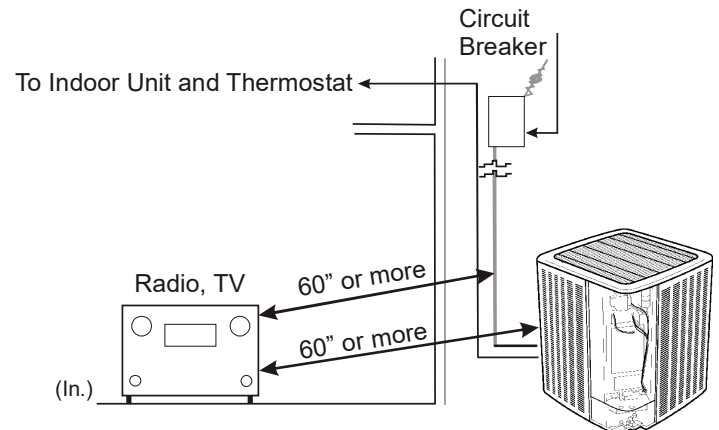

PLACEMENT TO MINIMIZE ELECTRONIC NOISE

SAFETY CONSIDERATION

Read these Safety considerations for Installation carefully before installing an outdoor unit. After completing the installation, make sure that the unit operates properly during the system start-up operation. Instruct the customer on how to operate and maintain the unit. Inform customers that they should store this Installation Manual for future reference. Always use a licensed installer or contractor to install this product. Improper installation can result in water or refrigerant leakage, electrical shock, fire, or explosion.

While these items will not cover every conceivable situation, they should serve as a useful guide.



WARNING

TO AVOID POSSIBLE INJURY, EXPLOSION OR DEATH, PRACTICE SAFE HANDLING OF REFRIGERANTS.



WARNING

TO AVOID POSSIBLE EXPLOSION, USE ONLY RETURNABLE (NOT DISPOSABLE) SERVICE CYLINDERS WHEN REMOVING REFRIGERANT FROM A SYSTEM.

- ENSURE THE CYLINDER IS FREE OF DAMAGE WHICH COULD LEAD TO A LEAK OR EXPLOSION.
- ENSURE THE HYDROSTATIC TEST DATE DOES NOT EXCEED 5 YEARS.
- ENSURE THE PRESSURE RATING MEETS OR EXCEEDS 400 PSIG. WHEN IN DOUBT, DO NOT USE CYLINDER.



CAUTION

- REFRIGERANT R410A IN THE SYSTEM MUST BE KEPT CLEAN, DRY, AND TIGHT.
- (A) CLEAN AND DRY - FOREIGN MATERIALS (INCLUDING MINERAL OILS SUCH AS SUNISO OIL OR MOISTURE) SHOULD BE PREVENTED FROM GETTING INTO THE SYSTEM.
- (B) TIGHT - R410A DOES NOT CONTAIN ANY CHLORINE, DOES NOT DESTROY THE OZONE LAYER, AND DOES NOT REDUCE THE EARTH'S PROTECTION AGAIN HARMFUL ULTRAVIOLET RADIATION. R410A CAN CONTRIBUTE TO THE GREENHOUSE EFFECT IF IT IS RELEASED. THEREFORE TAKE PROPER MEASURES TO CHECK FOR THE TIGHTNESS OF THE REFRIGERANT PIPING INSTALLATION. READ THE CHAPTER REFRIGERANT PIPING AND FOLLOW THE PROCEDURES.
- SINCE R410A IS A BLEND, THE REQUIRED ADDITIONAL REFRIGERANT MUST BE CHARGED IN ITS LIQUID STATE. IF THE REFRIGERANT IS CHARGED IN A STATE OF GAS, ITS COMPOSITION CAN CHANGE AND THE SYSTEM WILL NOT WORK PROPERLY.



CAUTION

- DO NOT TOUCH THE SWITCH WITH WET FINGERS. TOUCHING A SWITCH WITH WET FINGERS MAY RESULT IN ELECTRIC SHOCK.
- DO NOT ALLOW CHILDREN TO PLAY ON OR AROUND THE UNIT OR IT MAY RESULT IN INJURY.
- THE HEAT EXCHANGER FINS ARE SHARP ENOUGH TO CUT, AND MAY RESULT IN INJURY IF IMPROPERLY USED. TO AVOID INJURY WEAR GLOVE OR COVER THE FINS WHEN WORKING AROUND THEM.
- DO NOT TOUCH THE REFRIGERANT PIPES DURING AND IMMEDIATELY AFTER OPERATION AS THE REFRIGERANT PIPES MAY BE HOT OR COLD, DEPENDING ON THE CONDITION OF THE REFRIGERANT FLOWING THROUGH THE REFRIGERANT PIPING, COMPRESSOR, AND OTHER REFRIGERANT CYCLE PARTS. IT MAY RESULT IN YOUR HANDS GETTING BURNS OR FROSTBITE IF YOU TOUCH THE REFRIGERANT PIPES. TO AVOID INJURY, GIVE THE PIPES TIME TO RETURN TO NORMAL TEMPERATURE OR, IF YOU MUST TOUCH THEM, BE SURE TO WEAR PROPER GLOVES.
- INSULATE SUCTION PIPING TO PREVENT CONDENSATION.
- BE CAREFUL WHEN TRANSPORTING THE PRODUCT.
- TAKE ADEQUATE MEASURES TO PREVENT THE OUTDOOR UNIT FROM BEING USED AS A SHELTER BY SMALL ANIMALS. SMALL ANIMALS MAKING CONTACT WITH ELECTRICAL PARTS MAY RESULT IN MALFUNCTIONS, SMOKE, OR FIRE. INSTRUCT THE CUSTOMER TO KEEP THE AREA AROUND THE UNIT CLEAN.



WARNING

- DO NOT GROUND UNITS TO WATER PIPES, SUCTION LINE, TELEPHONE WIRES, OR LIGHTNING RODS AS INCOMPLETE GROUNDING WILL RESULT A SEVERE SHOCK HAZARD RESULTING IN SEVERE INJURY OR DEATH. ADDITIONALLY, GROUNDING TO GAS PIPES WILL RESULT A GAS LEAK AND POTENTIAL EXPLOSION RESULTING IN SEVERE INJURY OR DEATH.
- SAFELY DISPOSE ALL PACKING AND TRANSPORTATION MATERIALS IN ACCORDANCE WITH FEDERAL/STATE/LOCAL LAWS OR ORDINANCES. PACKING MATERIALS SUCH AS NAILS AND OTHER METAL OR WOOD PARTS, INCLUDING PLASTIC PACKING MATERIALS USED FOR TRANSPORTATION WILL RESULT IN INJURIES OR DEATH BY SUFFOCATION.
- ONLY QUALIFIED PERSONNEL MUST CARRY OUT THE INSTALLATION WORK. INSTALLATION MUST BE DONE IN ACCORDANCE WITH THIS INSTALLATION MANUAL. IMPROPER INSTALLATION COULD RESULT IN WATER LEAKAGE, ELECTRIC SHOCK, OR FIRE.
- USE ONLY SPECIFIED ACCESSORIES AND PARTS FOR INSTALLATION WORK. FAILURE TO USE SPECIFIED PARTS COULD RESULT IN WATER LEAKAGE, ELECTRIC SHOCKS, FIRE, OR THE UNIT FALLING.
- INSTALL THE OUTDOOR UNIT ON A FOUNDATION STRONG ENOUGH THAT IT CAN WITHSTAND THE WEIGHT OF THE UNIT. A FOUNDATION OF INSUFFICIENT STRENGTH COULD RESULT IN THE UNIT FALLING AND CAUSING INJURIES.
- TAKE INTO ACCOUNT STRONG WINDS, HURRICANE, OR EARTHQUAKES WHEN INSTALLING. IMPROPER INSTALLATION COULD RESULT IN THE UNIT FALLING AND CAUSING ACCIDENTS.
- MAKE SURE THAT A SEPARATE POWER SUPPLY CIRCUIT IS PROVIDED FOR THIS UNIT AND THAT ALL ELECTRICAL WORK IS CARRIED OUT BY QUALIFIED PERSONNEL ACCORDING TO LOCAL, STATE AND NATIONAL REGULATIONS. AN INSUFFICIENT POWER SUPPLY CAPACITY OR IMPROPER ELECTRICAL CONSTRUCTION COULD RESULT IN ELECTRIC SHOCKS OR FIRE.
- MAKE SURE THAT ALL WIRING IS SECURED, THAT SPECIFIED WIRES ARE USED, AND THAT NO EXTERNAL FORCES ACT ON THE TERMINAL CONNECTIONS OR WIRES. IMPROPER CONNECTIONS OR INSTALLATION COULD RESULT IN FIRE.
- WHEN WIRING, POSITION THE WIRES SO THAT THE SIDE PLATE WHICH COVERS TERMINAL BLOCK OF POWER CABLE CAN BE SECURELY FASTENED. IMPROPER POSITIONING OF THE SIDE PLATE COULD RESULT IN ELECTRIC SHOCKS, FIRE, OR THE TERMINALS OVERHEATING.
- DO NOT CHANGE THE SETTING OF THE PROTECTION DEVICES. IF THE PRESSURE SWITCH, THERMAL SWITCH, OR OTHER PROTECTION DEVICE IS SHORTED AND OPERATED FORCIBLY, OR PARTS OTHER THAN THOSE SPECIFIED BY DAIKIN ARE USED, FIRE OR EXPLOSION COULD RESULT.

NOTICE

- IF THE CONVENTIONAL REFRIGERANT AND REFRIGERATOR OIL ARE MIXED IN R410A, DETERIORATION WILL RESULT.
- THIS OUTDOOR UNIT IS AN APPLIANCE THAT SHOULD NOT BE ACCESSIBLE TO THE GENERAL PUBLIC.
- AS DESIGN PRESSURE IS 450 PSI (3.1 MPA), THE WALL THICKNESS OF FIELD-INSTALLED PIPES SHOULD BE SELECTED IN ACCORDANCE WITH THE RELEVANT LOCAL, STATE, AND NATIONAL REGULATIONS.



WARNING

REFRIGERANTS ARE HEAVIER THAN AIR. THEY CAN “PUSH OUT” THE OXYGEN IN YOUR LUNGS OR IN ANY ENCLOSED SPACE. TO AVOID POSSIBLE DIFFICULTY IN BREATHING OR DEATH:

- NEVER PURGE REFRIGERANT INTO AN ENCLOSED ROOM OR SPACE. BY LAW, ALL REFRIGERANTS MUST BE RECLAIMED.
- IF AN INDOOR LEAK IS SUSPECTED, THOROUGHLY VENTILATE THE AREA BEFORE BEGINNING WORK.
- LIQUID REFRIGERANT CAN BE VERY COLD. TO AVOID POSSIBLE FROST BITE OR BLINDNESS, AVOID CONTACT AND WEAR GLOVES AND GOGGLES. IF LIQUID REFRIGERANT DOES CONTACT YOUR SKIN OR EYES, SEEK MEDICAL HELP IMMEDIATELY.
- IF REFRIGERANT GAS LEAKS DURING INSTALLATION, VENTILATE THE AREA IMMEDIATELY. REFRIGERANT GAS WILL RESULT IN PRODUCING TOXIC GAS IF IT COMES INTO CONTACT WITH FIRE. EXPOSURE TO THIS GAS WILL RESULT IN SEVERE INJURY OR DEATH.
- AFTER COMPLETING THE INSTALLATION WORK, CHECK THAT THE REFRIGERANT GAS DOES NOT LEAK THROUGHOUT THE SYSTEM.
- DO NOT INSTALL UNIT IN AN AREA WHERE FLAMMABLE MATERIALS ARE PRESENT DUE TO RISK OF EXPLOSIONS THAT WILL RESULT IN SERIOUS INJURY OR DEATH.
- WHEN INSTALLING THE UNIT IN A SMALL ROOM, TAKE MEASURES TO KEEP THE REFRIGERANT CONCENTRATION FROM EXCEEDING ALLOWABLE SAFETY LIMITS. EXCESSIVE REFRIGERANT LEAKS, IN THE EVENT OF AN ACCIDENT IN A CLOSED AMBIENT SPACE, COULD RESULT IN OXYGEN DEFICIENCY.
- ALWAYS FOLLOW EPA REGULATIONS. NEVER BURN REFRIGERANT, AS POISONOUS GAS WILL BE PRODUCED.



WARNING

TO AVOID POSSIBLE EXPLOSION:

- NEVER APPLY FLAME OR STEAM TO A REFRIGERANT CYLINDER. IF YOU MUST HEAT A CYLINDER FOR FASTER CHARGING, PARTIALLY IMMERSE IT IN WARM WATER.
- NEVER FILL A CYLINDER MORE THAN 80% FULL OF LIQUID REFRIGERANT.
- NEVER ADD ANYTHING OTHER THAN R-410A TO A RETURNABLE R-410A CYLINDER. THE SERVICE EQUIPMENT USED MUST BE LISTED OR CERTIFIED FOR THE TYPE OF REFRIGERANT USE.
- STORE CYLINDERS IN A COOL, DRY PLACE. NEVER USE A CYLINDER AS A PLATFORM OR A ROLLER.

MEANINGS OF SYMBOLS



WARNING Indicates imminently or potentially hazardous situation which, if not avoided, will result in death or serious injury.



CAUTION Indicates a potentially hazardous situation which, if not avoided, may result in minor or moderate injury. It may also be used to alert against unsafe practices.

NOTICE Indicates situations that may result in equipment or property-damage accidents only.

While these items will not cover every conceivable situation, they should serve as a useful guide.

REFRIGERANT LINES



CAUTION

THE COMPRESSOR PVE OIL FOR R-410A UNITS IS EXTREMELY SUSCEPTIBLE TO MOISTURE ABSORPTION AND COULD CAUSE COMPRESSOR FAILURE. DO NOT LEAVE SYSTEM OPEN TO ATMOSPHERE ANY LONGER THAN NECESSARY FOR INSTALLATION.

Use only refrigerant grade (dehydrated and sealed) copper tubing to connect the heat pump unit with the indoor unit. After cutting the tubing, install plugs to keep refrigerant tubing clean and dry prior to and during installation. Tubing should always be cut square keeping ends round and free from burrs. Clean the tubing to prevent contamination. The liquid line must be insulated if more than 50 ft. of liquid line will pass through an area that may reach temperatures of 30 °F or higher than ambient in cooling mode and/or if the temperature inside the conditioned space may reach a temperature lower than ambient in heating mode. Never attach a liquid line to any uninsulated portion of the suction line.

Do NOT let refrigerant lines come in direct contact with plumbing, ductwork, floor joists, wall studs, floors, and walls. When running refrigerant lines through a foundation or wall, openings should allow for sound and vibration absorbing material to be placed or installed between tubing and foundation. Any gap between foundation or wall and refrigerant lines should be filled with a pliable silicon-based caulk, RTV or a vibration damping material. Avoid suspending refrigerant tubing from joists and studs with rigid wire or straps that would come in contact with the tubing. Use an insulated or suspension type hanger. Keep both lines separate and always insulate the suction line.

Insulation is necessary to prevent condensation from forming and dropping from the suction line. Armflex or satisfactory equivalent with 3/8” min. wall thickness is recommended. In severe conditions (likely to exceed 86°F and a relative humidity of 80%) 1/2” insulation may be required. Insulation must be installed in a manner which protects tubing and connections from damage and contamination.

Where possible, drain as much residual compressor oil from existing systems, lines, and traps; pay close attention to low areas where oil may collect. **NOTE:** If changing refrigerant, the indoor coil and metering device must be replaced. Only AVPEC** / AMVE** air handlers or coils with TXV-V** expansion valve are compatible and have been manufacturer approved for use with these models.

See unit specifications or AHRI for an approved system match.

Air Conditioner BELOW Indoor Coil

Mounting the indoor coil above the Air Conditioning Unit will require an inverted loop in the gas line adjacent or near the connection to the indoor coil, for the purpose of creating an oil trap. The top of the loop must be slightly higher than the top of the coil.

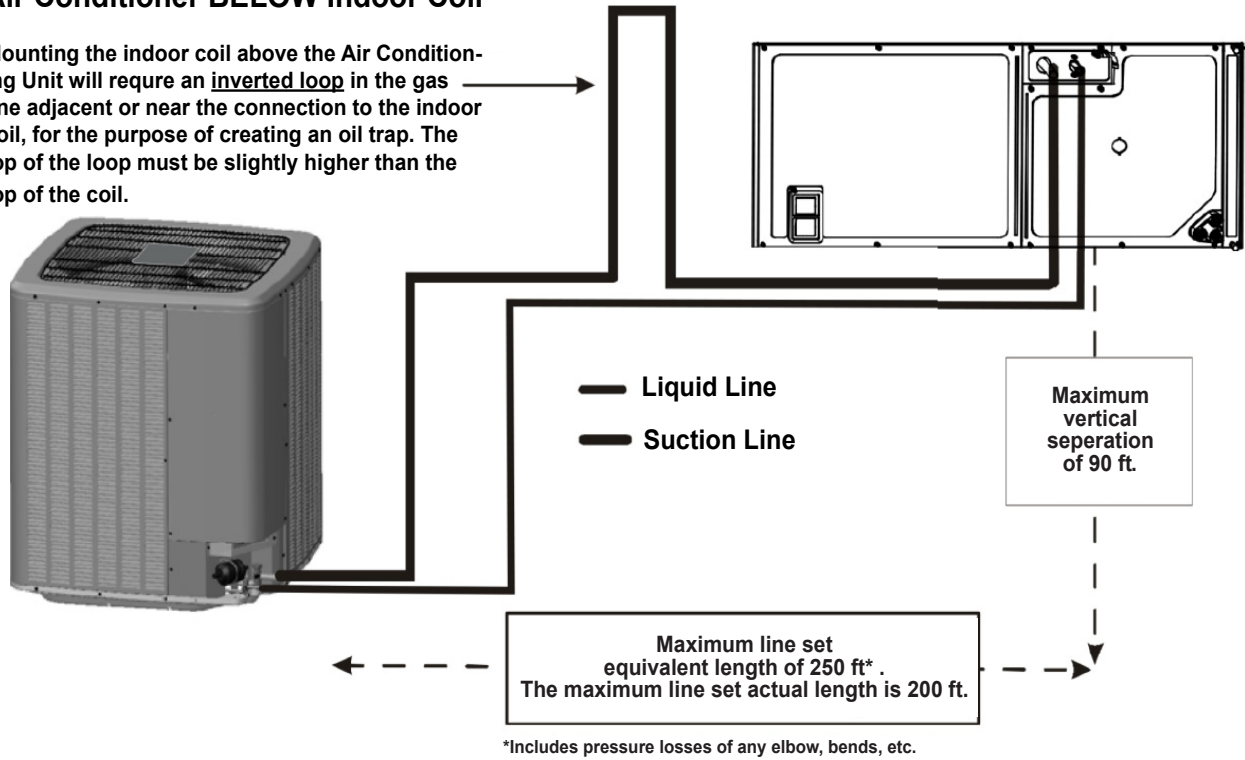

NOTE: If Height difference between Condenser and Evaporator is more than 15 ft, then refer to these diagrams.

Condenser ABOVE Evaporator

Mounting the condensing unit above the evaporator coil will require an oil trap that is vertically centered between the condensing unit and the air handler IF the vertical separation exceeds 80 ft. The trap can be constructed from the standard refrigerant fittings as shown in the figure (bottom left).

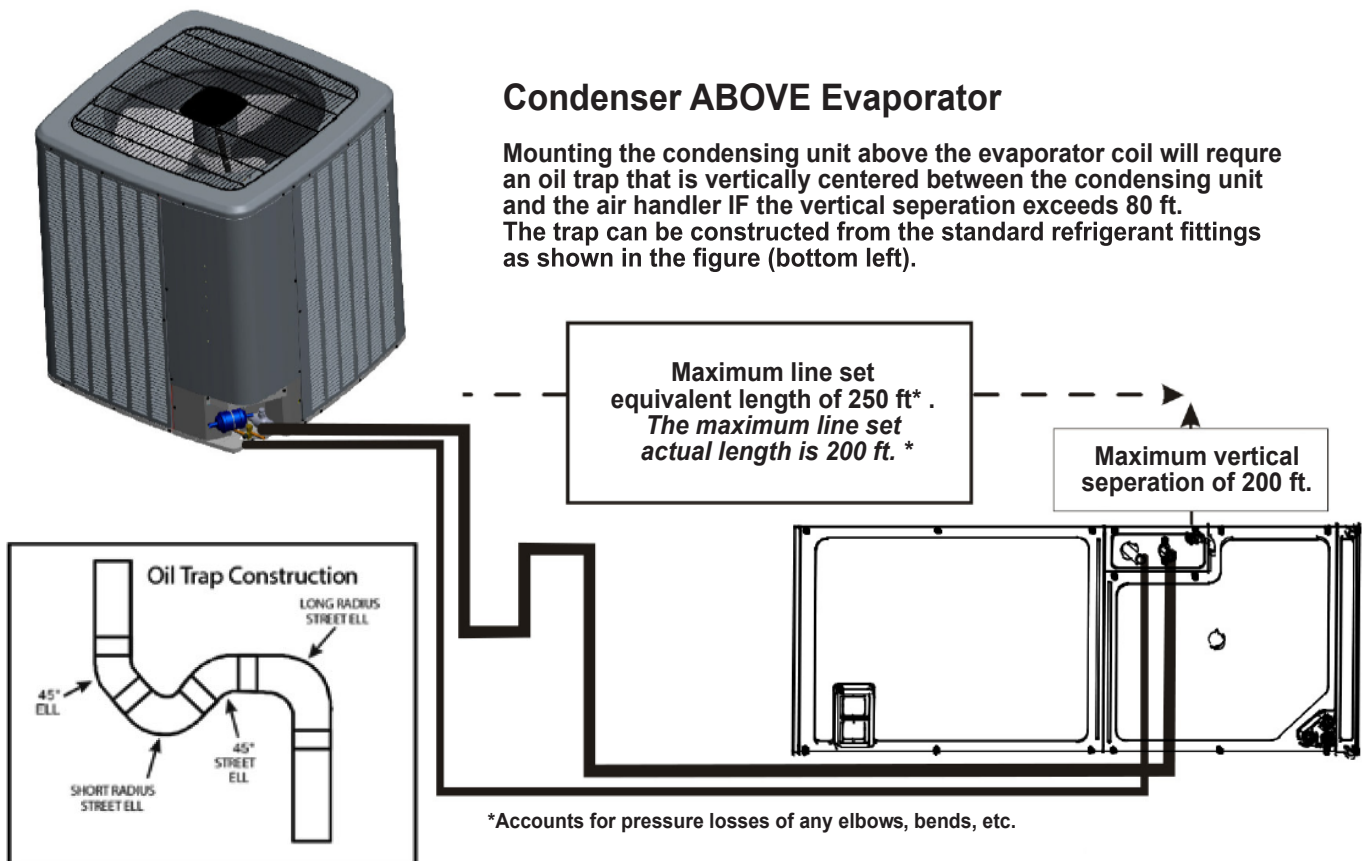

BURYING REFRIGERANT LINES

If burying refrigerant lines can't be avoided, use the following checklist.

1. Insulate liquid and suction lines separately.
2. Enclose all underground portions of the refrigerant lines in waterproof material (conduit or pipe) sealing the ends where tubing enters/exits the enclosure.
3. If the lines must pass under or through a concrete slab, ensure lines are adequately protected and sealed.

INTERCONNECTING TUBING		
Line Set Length	0 - 250' Equivalent	
Heat Pump Unit	Line Type & Line Diameter (In. OD)	
(Tons)	Suct	Liq
2	3/4	3/8
3	7/8	3/8
4	1 1/8	3/8
5	1 1/8	3/8

REFRIGERANT LINE CONNECTIONS

IMPORTANT: To avoid overheating the service valve, TXV, sensor, or filter drier while brazing, wrap the component with a wet rag, or use a thermal heat trap compound. Be sure to follow the manufacturer's instruction when using the heat trap compound. Note: Remove Schrader valves from service valves before brazing tubes to the valves. After brazing temperature is reached, use a brazing alloy of 2% minimum silver content. Do not use flux.

Torch heat required to braze tubes of various sizes is proportional to the size of the tube. Tubes of smaller size require less heat to bring the tube to brazing temperature before adding brazing alloy. Applying too much heat to any tube can melt the tube. Service personnel must use the appropriate heat level for the size of the tube being brazed.

NOTE: THE USE OF A HEAT SHIELD WHEN BRAZING IS RECOMMENDED TO AVOID BURNING THE SERIAL PLATE OR THE FINISH ON THE UNIT.

1. The ends of the refrigerant lines must be cut square, deburred, cleaned, and be round and free from nicks or dents. Any other condition increases the chance of a refrigerant leak.
2. Purge with nitrogen at 2 to 3 psig during brazing to prevent the formation of copper-oxide inside the refrigerant lines. The FVC oils used in R-410A applications will clean any copper-oxide present from the inside of the refrigerant lines and spread it throughout the system. This may cause a blockage or failure of the metering device.
3. After brazing, quench the joints with water or a wet cloth to prevent overheating of the service valve.

4. A bi-flow filter drier is shipped with the unit as a separate component and must be brazed on by the installer on-site. Ensure the bi-flow filter drier paint finish is intact after brazing. If the paint of the steel filter drier has been burned or chipped, repaint or treat with a rust preventative.

The recommended location of the filter drier is before the expansion device at the indoor unit.

NOTE: BE CAREFUL NOT TO KINK OR DENT REFRIGERANT LINES. KINKED OR DENTED LINES WILL CAUSE POOR PERFORMANCE OR COMPRESSOR DAMAGE.

Do NOT make final refrigerant line connection until plugs are removed from refrigerant tubing.

STANDING PRESSURE TEST (RECOMMENDED BEFORE SYSTEM EVACUATION)

Using dry nitrogen, pressurize the system to 450 PSIG. Allow the pressure to stabilize and hold for 15 minutes (minimum). If the pressure does not drop below 450 PSIG the system is considered leak free. Proceed to system evacuation using the Deep Vacuum Method. If after 15 minutes the pressure drops below 450 PSIG follow the procedure outlined below to identify system leaks. Repeat the Standing Pressure Test.

LEAK TESTING (NITROGEN OR NITROGEN-TRACED)

 WARNING
<p>TO AVOID THE RISK OF FIRE OR EXPLOSION, NEVER USE OXYGEN, HIGH PRESSURE AIR OR FLAMMABLE GASES FOR LEAK TESTING OF A REFRIGERATION SYSTEM.</p>

 WARNING
<p>TO AVOID POSSIBLE EXPLOSION, THE LINE FROM THE NITROGEN CYLINDER MUST INCLUDE A PRESSURE REGULATOR AND A PRESSURE RELIEF VALVE. THE PRESSURE RELIEF VALVE MUST BE SET TO OPEN AT NO MORE THAN 450 PSIG.</p>

Leak test the system using dry nitrogen and soapy water to identify leaks. If you prefer to use an electronic leak detector, charge the system to 10 PSIG with the appropriate system refrigerant (see Serial Data Plate for refrigerant identification). Do not use an alternative refrigerant. Using dry nitrogen finish charging the system to 450 PSIG. Apply the leak detector to all suspect areas. When leaks are discovered, repair the leaks, and repeat the pressure test. If leaks have been eliminated proceed to system evacuation.

SYSTEM EVACUATION

Condensing unit liquid and suction valves are closed to contain the charge within the unit. The unit is shipped with the valve stems closed and caps installed. Do not open valves until the system is evacuated.



WARNING

**REFRIGERANT UNDER PRESSURE!
FAILURE TO FOLLOW PROPER PROCEDURES MAY CAUSE
PROPERTY DAMAGE, PERSONAL INJURY OR DEATH.**

**NOTE: SCROLL COMPRESSORS SHOULD NEVER BE USED
TO EVACUATE OR PUMP DOWN A HEAT PUMP OR AIR
CONDITIONING SYSTEM.**



CAUTION

**PROLONGED OPERATION AT SUCTION PRESSURES LESS
THAN 20 PSIG FOR MORE THAN 5 SECONDS WILL RESULT IN
OVERHEATING OF THE SCROLLS AND PERMANENT DAMAGE
TO THE SCROLL TIPS, DRIVE BEARINGS AND INTERNAL
SEAL.**

DEEP VACUUM METHOD (RECOMMENDED)

The Deep Vacuum Method requires a vacuum pump rated for 500 microns or less. This method is an effective and efficient way of assuring the system is free of non-condensable air and moisture. As an alternative, the Triple Evacuation Method is detailed in the Service Manual for this product model.

It is recommended to remove the Schrader Cores from the service valves using a core-removal tool to expedite the evacuation procedure.

1. Connect the vacuum pump, micron gauge, and vacuum rated hoses to both service valves. Evacuation must use both service valves to eliminate system mechanical seals.
2. Evacuate the system to less than 500 microns.
3. Isolate the pump from the system and hold vacuum for 10 minutes (minimum). Typically, pressure will rise slowly during this period. If the pressure rises to less than 1000 microns and remains steady, the system is considered leak-free; proceed to system charging and startup.
4. If pressure rises above 1000 microns but holds steady below 2000 microns, non-condensable air or moisture may remain or a small leak is present. Return to step 2: If the same result is achieved check for leaks and repair. Repeat the evacuation procedure.
5. If pressure rises above 2000 microns, a leak is present. Check for leaks and repair. Repeat the evacuation procedure.

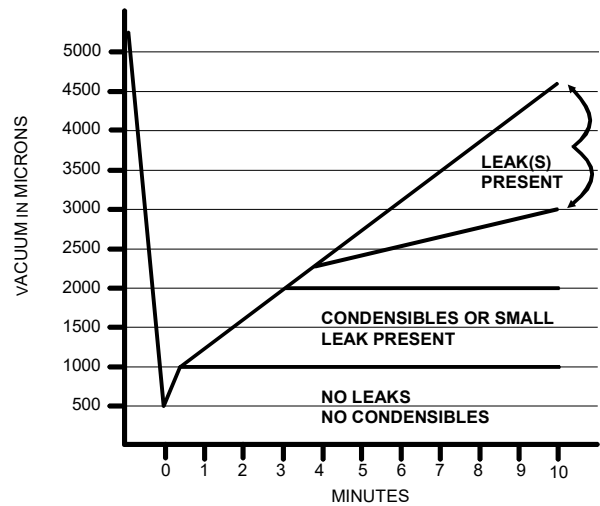

SYSTEM START-UP PROCEDURE

GENERAL NOTES:

Adequate refrigerant charge for the matching evaporator coil and 15 feet of line set is supplied with the condensing unit. If line set exceeds 15 feet in length, refrigerant should be added at 0.6 ounces per foot of liquid line.

START-UP PROCEDURE DETAIL

Condensing unit liquid and suction valves are closed to contain the charge within the unit. The unit is shipped with the valve stems closed and caps installed. **Do not open valves until the indoor coil and line set is evacuated.**

ELECTRICAL CONNECTIONS



WARNING

HIGH VOLTAGE

**DISCONNECT ALL POWER BEFORE SERVICING
OR INSTALLING THIS UNIT. MULTIPLE POWER
SOURCES MAY BE PRESENT. FAILURE TO DO SO
MAY CAUSE PROPERTY DAMAGE, PERSONAL
INJURY OR DEATH. DO NOT SERVICE THIS UNIT
WITHOUT FIRST INSURING THAT:**



**THE ELECTRICAL ACCESSORIES ARE INSTALLED ONLY IN
THE PRE-DRILLED MOUNTING HOLES.
THE ELECTRICAL WIRING IS NOT INSTALLED AND DOES NOT
HANG BELOW THE PRE-DRILLED MOUNTING HOLE OR LIE IN
THE UNIT BASE PAN.**



WARNING

**TO AVOID THE RISK OF FIRE OR EQUIPMENT DAMAGE, USE
COPPER CONDUCTORS.**



CAUTION

GROUNDING REQUIRED!

ALWAYS INSPECT AND USE PROPER SERVICE TOOLS. LACK OF INSPECTION OR IMPROPER TOOLS MAY CAUSE EQUIPMENT DAMAGE OR PERSONAL INJURY. ALL DISCONNECTED GROUNDING DEVICES MUST BE RECONNECTED BEFORE INSTALLING OR SERVICING. MULTIPLE COMPONENTS OF THIS UNIT MAY CONDUCT ELECTRICAL CURRENT; THESE ARE GROUNDED. IF SERVICING THE UNIT, ANY DISCONNECTION OF GROUNDING WIRES, SCREWS, STRAPS, CLIPS, NUTS OR WASHERS USED TO COMPLETE THE GROUND MUST BE RETURNED TO THEIR ORIGINAL POSITION AND PROPERLY



NOTICE

- NEVER INSTALL A PHASE-ADVANCING CAPACITOR. AS THIS UNIT IS EQUIPPED WITH AN INVERTER, INSTALLING A PHASE-ADVANCING CAPACITOR WILL NOT ONLY DETERIORATE POWER FACTOR IMPROVEMENT EFFECT, BUT ALSO MAY CAUSE CAPACITOR ABNORMAL HEATING ACCIDENT DUE TO HIGH-FREQUENCY WAVES.
- DO NOT CHANGE THE SETTING OF THE PROTECTION DEVICES. IF THE PRESSURE SWITCH, THERMAL SWITCH, OR OTHER PROTECTION DEVICE IS SHORTED AND OPERATED FORCIBLY, OR PARTS OTHER THAN THOSE SPECIFIED BY GOODMAN ARE USED, FIRE OR EXPLOSION COULD RESULT.
- DO NOT CONNECT THE GROUND WIRE TO GAS PIPES, SEWAGE PIPES, LIGHTNING RODS, OR TELEPHONE GROUND WIRES.

HIGH VOLTAGE CONNECTIONS

The air conditioning unit rating plate lists pertinent electrical data necessary for proper electrical service and overcurrent protection. Wires should be sized to limit voltage drop to 2% (max.) from the main breaker or fuse panel to the condensing unit. Consult the NEC, CEC, and all local codes to determine the correct wire gauge and length.

Local codes often require a disconnect switch located near the unit; do not install the switch on the unit.

Route power supply and ground wires through the high voltage port and terminate in accordance with the wiring diagram provided inside the control panel cover.

- Make sure to apply the rated voltage of 208/230V for the unit.
- Use conduit for power supply cables.
- A power circuit (see the production specification sheet or the unit serial plate) must be provided for connection of the unit. This circuit must be protected with the required safety devices.
- When using residual current operated circuit breakers, be sure to use a high-speed type (0.1 seconds or less) 200 mA rated residual operating current.
- Use copper conductors only.
- Use insulated wire for the power cord.
- Select the power supply cable type and size in accordance with relevant local and national regulations.

- Outside the unit, make sure to keep the wirings 5 inch away. Otherwise, the outdoor unit may be affected by electrical noise (external noise), and malfunction or fail.
- Make sure the wirings will not be pinched by the front panel, and close the panel firmly.
- Route the conduit along the unit and so on to prevent wirings from being stepped on.

LOW VOLTAGE CONNECTIONS

The unit is designed to work as part of a fully communicating HVAC system, utilizing either:

- ComfortBridge compatible indoor unit with any 24V single stage thermostat.

Route control wires through the low voltage port and terminate in accordance with the wiring diagram provided inside the control panel cover.

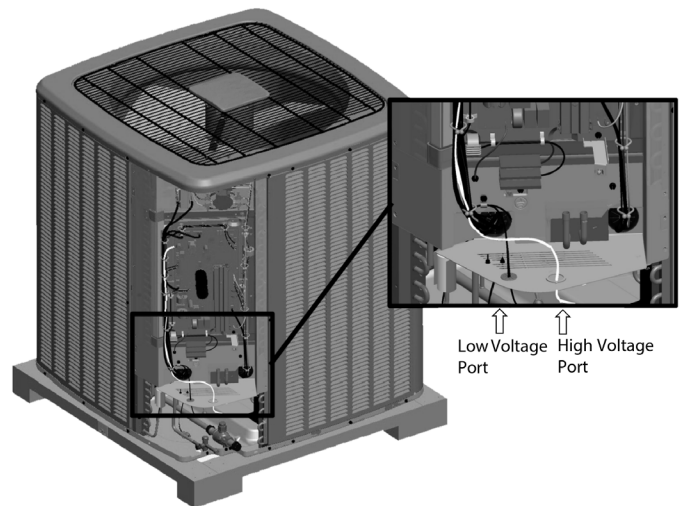

VOLTAGE PORTS

THERMOSTAT WIRING

ComfortBridge™ control system low voltage wiring consists of two wires between the indoor unit and outdoor unit. The required wires are data lines 1 and 2.

The thermostat needs 4 wires between the indoor unit and thermostat or 5 wires if the thermostat requires a Common wire.

Regarding the wiring of the indoor unit to the thermostat, also refer to ComfortBridge compatible indoor unit's Install manual (in case of communicating inverter system.).

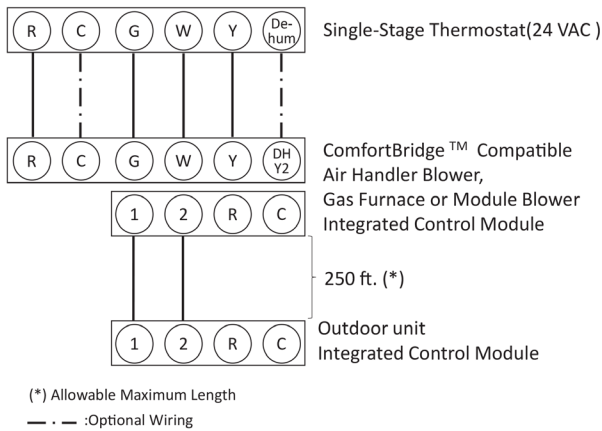

SYSTEM WIRING

STEP 1. CALCULATE REFRIGERANT CHARGE BASED ON LINE SET LENGTH

The condenser unit is shipped with a predetermined factory charge level as shown in unit serial plate. For longer line sets greater than 15 feet, add 0.6 ounces of refrigerant per foot. Refer to the following page for the equivalent length of the elbow fittings.

NOTICE
TOTAL REFRIGERANT = FACTORY CHARGE + (0.6 OZ./FT. * ADDITIONAL FEET OF ACTUAL LINE SET).

STEP 2. CONNECT MANIFOLD GAUGES TO SYSTEM

CAUTION
OPEN THE LIQUID VALVE FIRST! IF THE SUCTION SERVICE VALVE IS OPENED FIRST, OIL FROM THE COMPRESSOR MAY BE DRAWN INTO THE INDOOR COIL TXV RESTRICTING REFRIGERANT FLOW AND AFFECTING OPERATION OF THE SYSTEM.

CAUTION
POSSIBLE REFRIGERANT LEAK! TO AVOID A POSSIBLE REFRIGERANT LEAK, OPEN THE SERVICE VALVES UNTIL THE TOP OF THE STEM IS 1/8" FROM THE RETAINER.

CAUTION
ENSURE VALVES ARE OPEN AND ADDITIONAL CHARGE IS ADDED PER CHART BEFORE APPLYING POWER.

When opening valves with retainers, open each valve only until the top of the stem is 1/8" from the retainer. To avoid loss of refrigerant, DO NOT apply pressure to the retainer. When opening valves without a retainer, remove service valve cap and insert a hex wrench into the valve stem and back out the stem by turning the hex wrench counterclockwise. Open the valve until it contacts the rolled lip of the valve body.

Charge additional refrigerant calculated by STEP 1 formula from liquid service valve (NOT from suction side).

After the refrigerant charge has bled into the system, open the liquid service valve.

The service valve cap is the secondary seal for the valves and must be properly tightened to prevent leaks. Make sure cap is clean and apply refrigerant oil to threads and sealing surface on inside of cap. Tighten cap finger-tight and then tighten additional 1/6 of a turn to properly seat the sealing surfaces.

Do not introduce liquid refrigerant from the cylinder into the crankcase of the compressor (suction side) as this may damage the compressor.

Break vacuum by fully opening liquid and gas base valve.

NOTE. UNITS MAY UTILIZE BALL VALVES OR FRONT SEATING VALVES. THESE ARE NOT BACK-SEATING VALVES. IT IS NOT NECESSARY TO FORCE THE STEM TIGHTLY AGAINST THE ROLLED LIP.

NOTE: THE FOLLOWING TABLE LISTS THE EQUIVALENT LENGTH GAINED FROM ADDING BENDS TO THE SUCTION LINE. PROPERLY SIZE THE SUCTION LINE TO MINIMIZE CAPACITY LOSS.

Type of Elbow Fitting	Inside Diameter (inches)		
	3/4	7/8	1 1/8
90° short radius	1.7	2	2.3
90° long radius	1.5	1.7	1.6
45°	0.7	0.8	1

STEP 3. SYSTEM START-UP TEST

NOTICE
ON INITIAL POWER START-UP, THE OUTDOOR UNIT WILL DISPLAY CODE E11, SIGNALING THAT INITIAL SYSTEM TEST MUST BE RUN. FOLLOW THE INSTRUCTIONS BELOW TO INITIATE AND COMPLETE THE TESTING.

A system verification test is now required to check the equipment settings and functionality.

Inverter units are tested by any of the following methods:

- Setting the "SUT" menu (System verification test) to ON through the indoor unit control board push buttons.
- Setting the System verification test menu of mode display screen-4 to ON through the outdoor unit control board push buttons.
- Through the CoolCloud HVAC phone application

Once selected, it checks the equipment for approximately 5 - 15 minutes. System test may exceed 15 minutes if there is an error. Refer to the Troubleshooting section.



NOTICE

BEFORE STARTING THE SYSTEM TEST, TURN OFF THE ELECTRIC HEATER OR GAS FURNACE.

COOLCLOUD™ HVAC PHONE APPLICATION

The CoolCloud HVAC phone application was designed to improve the contractor's setup /diagnostic experience. This application can only be used with ComfortBridge compatible indoor units and can be downloaded through the Google Play or Apple App Store.

Users can see specific model information, review active diagnostic error codes, observe system status during operation, make system menu adjustments, add site visit notes and run system testing of all operational modes (heat / cool / fan) directly from the phone.

STEP 4. CHARGE MODE

CHARGE MODE allows for charging of the system.

System operates for a duration of approximately one hour while the equipment runs at full capacity.

After one hour, the CHARGE MODE ends and the system resumes normal operation.

Before starting the CHARGE MODE, turn off the Cool or Heat mode and electric heater or gas furnace.

- Inverter units are charged by any of the following methods:
 - Setting the "CR9" menu (Charge Mode) to ON through the indoor unit control board push buttons.
 - Setting the Charge mode menu of mode display screen-4 to ON through the outdoor unit control board push buttons.
 - Through the CoolCloud HVAC phone application.
- The System will remain in charge mode (high speed) for 60 minutes before timing out.
- When charge mode is complete, the installer must manually shut off.

STEP 5. ADJUST REFRIGERANT LEVEL

Using service equipment, add or recover refrigerant according to the calculation in Step 1. Allow system to stabilize for 10 minutes after adjusting charge level.

STEP 6. MEASURE SUBCOOLING TO VERIFY PROPER CHARGE NOTE: CHARGING EQUIPMENT MUST USE DEDICATED PVE OIL GAUGES AND HOSES.

- Purge gauge lines.
- Connect service gauge manifold to base valve service ports.
- Convert the liquid pressure to temperature using a temperature/pressure chart.

- Temporarily install a thermometer on the liquid line at the liquid line service valve.
 - Ensure the thermometer makes adequate contact and is insulated for best possible readings.
- Subtract the liquid line temperature from the converted liquid pressure to determine subcooling.
- Before starting the subcooling adjustment, make sure the outdoor ambient temperature is in a below range and the unit is operating at 100% capacity.
- For EEV Indoor Unit: If the system subcooling is not within the ranges shown in the following table, adjust subcooling according to the following procedure:
 - If subcooling is low, add charge to adjust the subcooling as specified in the following table.
 - If subcooling is high, remove charge to lower the subcooling to $8^{\circ} \pm 1^{\circ}\text{F}$.

$$\text{SUBCOOLING} = (\text{SAT. LIQUID TEMP.}) - (\text{LIQUID LINE TEMP.})$$

$$\text{SUPERHEAT} = (\text{SUCT. LINE TEMP.}) - (\text{SAT. SUCT. TEMP.})$$

NOTICE

WHEN PUT INTO CHARGE MODE THE 7-SEGMENT DISPLAY WILL BEGIN BLINKING "CHA" LIGHTS. ONCE THE SYSTEM IS STABLE THE "CHA" LIGHTS WILL STOP BLINKING AND STAY SOLID (WILL TAKE AROUND 30 MINUTES). USING SERVICE EQUIPMENT, ADD OR RECOVER REFRIGERANT ACCORDING TO THE CALCULATION IN STEP 1. DO NOT ADJUST REFRIGERANT LEVEL IF THE "CHA" LIGHTS ARE NOT SOLID.

Charging Table

OD Ambient Temp (degF)	< 65 °F	65°F to 105°F	> 105 °F
Subcooling (degF)	Weigh in Charge	$8^{\circ}\text{F} \pm 1^{\circ}\text{F}$	Weigh in Charge

Note: Subcooling information is valid only while the unit is operating at 100% capacity or 100% of compressor speed in CHARGE MODE. Compressor speed is displayed under STATUS menu in the thermostat.

- For TXV Indoor Unit

The system subcooling should be $8^{\circ}\text{F} \pm 1^{\circ}\text{F}$. If not in that range, adjust subcooling and superheat according to the following procedure.

 - If subcooling and superheat are low, adjust TXV to $8^{\circ}\text{F} \pm 1^{\circ}\text{F}$ superheat, then check subcooling.

NOTE: TO ADJUST SUPERHEAT, TURN THE VALVE STEM CLOCKWISE TO INCREASE AND COUNTER CLOCKWISE TO DECREASE.

- If subcooling is low and superheat is $8^{\circ}\text{F} \pm 1^{\circ}\text{F}$, add charge to rise subcooling to $8^{\circ}\text{F} \pm 1^{\circ}\text{F}$, then check superheat.
- If subcooling is low and superheat is high, add charge to rise subcooling to $8^{\circ}\text{F} \pm 1^{\circ}\text{F}$, then check superheat.
- If subcooling is $8^{\circ}\text{F} \pm 1^{\circ}\text{F}$ and superheat is high, adjust the TXV valve to $8^{\circ}\text{F} \pm 1^{\circ}\text{F}$ superheat, then check subcooling.

- e. If subcooling and superheat are high, adjust the TXV valve to $8^{\circ}\text{F} \pm 1^{\circ}\text{F}$ superheat, then check subcooling.
- f. If subcooling is high and superheat is $8^{\circ}\text{F} \pm 1^{\circ}\text{F}$, remove charge to lower the subcooling to $8^{\circ}\text{F} \pm 1^{\circ}\text{F}$, then check superheat.
- g. If subcooling is high and superheat is low, adjust the TXV valve to $8^{\circ}\text{F} \pm 1^{\circ}\text{F}$ superheat and remove charge to low the subcooling to $8^{\circ}\text{F} \pm 1^{\circ}\text{F}$.
- h. If subcooling is $8^{\circ}\text{F} \pm 1^{\circ}\text{F}$ and superheat is low, adjust the TXV valve to $8^{\circ}\text{F} \pm 1^{\circ}\text{F}$ superheat and remove charge to lower the subcooling $8^{\circ}\text{F} \pm 1^{\circ}\text{F}$, then check the superheat.

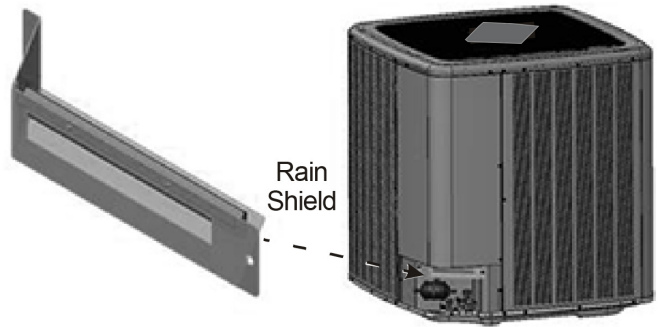

NOTICE

IF THE RAIN SHIELD WAS REMOVED DURING THE INSTALLATION PROCESS, BE SURE TO RE-INSTALL IT AFTER CHARGING THE UNIT.

NOTE: IT IS RECOMMENDED TO ADD CHARGE IN 4 OZ. INCREMENTS EACH TIME TO ACHIEVE THE TARGET SUBCOOLING.

NOTICE

CHECK THE SCHRADER PORTS FOR LEAKS AND TIGHTEN VALVE CORES, IF NECESSARY. INSTALL CAPS FINGER-TIGHT.

NOTICE

DO NOT ADJUST THE CHARGE BASED ON SUCTION PRESSURE UNLESS THERE IS A GROSS UNDERCHARGE.

OUTDOOR UNIT DIPSWITCH FACTORY DEFAULT SETTINGS			
Switch #	Setting	Function	
DS1	1	ON	CT Communication Terminal Resister
	2	ON	CT Communication Terminal Resister
DS2	1	ON	Cooling Emergency Mode*
	2	ON	Cooling Emergency Mode*

* DS2 switch 1 and 2 both must be turned on during normal operation mode

FIELD SELECTABLE BOOST MODE

BOOST MODE can be enabled or disabled through the control board push buttons or through the CoolCloud app.

BOOST MODE allows the system to operate at increased compressor speed to satisfy unusually high loads. BOOST MODE is initiated by an outdoor temperature sensor located in the outdoor unit.

Please note that outdoor equipment operational sound levels may increase while the equipment is running in BOOST MODE. Disabling BOOST MODE will provide the quietest and most efficient operation.

NOTE: BOOST MODE is ON by default and is activated when the outdoor temperature reaches 105°F . BOOST MODE can be disabled and enabled and the activation temperature adjusted in the Settings menu of the CoolCloud app or through the indoor / outdoor push button menus.

DEHUMIDIFICATION

NOTE: FOR REGIONS WITH HIGH HUMIDITY, IT IS STRONGLY RECOMMENDED TO USE A THERMOSTAT WITH HUMIDITY SENSOR AND DEHUMIDIFICATION TERMINAL. WITHOUT THIS TYPE OF THERMOSTAT, DEHUMIDIFICATION OPERATION DOES NOT WORK.

Dehumidification requires a thermostat capable of reading the indoor humidity level and allowing the user to set a dehumidification target.

SATURATED SUCTION PRESSURE TEMPERATURE CHART	
SUCTION PRESSURE PSIG	R-410A °F
50	1
52	3
54	4
56	6
58	7
60	8
62	10
64	11
66	13
68	14
70	15
72	16
74	17
76	19
78	20
80	21
85	24
90	26
95	29
100	31
110	36
120	41
130	45
140	49
150	53
160	56
170	60

SATURATED LIQUID PRESSURE TEMPERATURE CHART	
LIQUID PRESSURE PSIG	R-410A °F
200	70
210	73
220	76
225	78
235	80
245	83
255	85
265	88
275	90
285	92
295	95
305	97
325	101
355	108
375	112
405	118
415	119
425	121
435	123
445	125
475	130
500	134
525	138
550	142
575	145
600	149
625	152

The thermostat controls the humidity level of the conditioned space using the cooling system. Dehumidification is engaged whenever a cooling demand is present and humidity levels are above the target level. When this condition exists, the circulating fan output is reduced, increasing system run time, over cooling the evaporator coil and ultimately removing more humidity from the structure than if only in cooling mode.

The thermostat may also allow for an additional overcooling limit setting depending on the thermostat utilized. This allows the cooling system to further reduce humidity by lowering the temperature below the cooling setpoint in an attempt to better achieve desired humidity levels.

DEHUMIDIFICATION TIPS

For effective dehumidification operation:

- Ensure “Dehumidification selection” is NOT set to “OFF”.
 - Verify the cooling airflow profile is set to “Profile D”.
- See the Cool Set-up section of the Installation Manual for complete airflow profile details.
- By default, “Dehumidification selection” is standard and the cooling airflow profile is set to “Profile D”.
- For additional dehumidification control, airflow settings are field adjustable and can be fine-tuned to a value that is comfortable for the application from a range of Cool Airflow Trim.
 - In addition, the system can have Enhanced Dehumidification operation in setting “A”, “B”, or “C” of “Dehumidification Selection” based on dehumidification demand.
- See the DEHUMIDIFICATION SELECT section of the Installation Manual for more detail.

COMFORTBRIDGE™ SYSTEM

OVERVIEW

The ComfortBridge based inverter heating and air conditioning system uses an indoor unit and outdoor unit digitally communicating with one another via a two-way communications path. ComfortBridge is compatible with any 24 VAC single stage thermostat which sends inputs to the indoor unit.

COMFORTBRIDGE SYSTEM ADVANCED FEATURES

The ComfortBridge system permits access to system information, advanced set-up features, and advanced diagnostic/troubleshooting features via the control board push buttons or the CoolCloud HVAC app.

FAULT CODE HISTORY

The air conditioner’s diagnostics menu provides access to the most recent faults. The six most recent faults can be accessed through the control board seven segment displays or the CoolCloud mobile app. Any consecutively repeated fault is stored a maximum of three times.

Example: A leak in the system, low refrigerant charge or an incompletely open stop valve can cause the unit to flash error code E15. This error code suggests that the unit is experiencing operation at low pressure. The control will only store this fault the first three consecutive times the fault occurs.

NOTE: THE FAULT LIST CAN BE CLEARED AFTER PERFORMING MAINTENANCE OR SERVICING THE SYSTEM TO ASSIST IN THE TROUBLESHOOTING PROCESS.

DEVICE STATUS

This menu displays information about the systems current status. This menu can be utilized to confirm correct functionality of the equipment and for troubleshooting purposes.

The following items will be displayed:

- Heat Capacity Request Percentage
 - Cool Capacity Request Percentage
 - Heat Capacity Request During Defrost Percentage
 - Dehumidification Request Percentage
 - Reversing Valve Status
 - Reported Airflow by Indoor Unit
 - Boost Mode
 - Previous Defrost Run Time
- * Information specific to the heat pump is not displayed.

SENSOR DATA

The following sensor values will be displayed:

- Outdoor Temperature
- Coil Temperature
- Liquid Line Temperature
- Discharge Temperature
- Defrost Sensor
- Suction Pressure

PUMP DOWN / CHARGE MODE

This function can be enabled in this menu.

* Information specific to the heat pump is not displayed.

COOL SET-UP

The system allows for the adjustment of several cooling performance variables. Cool Airflow Trim (*1), Cool Airflow Profiles, Cool Fan ON Delay, Cool Fan OFF Delay and Dehumidification Select (some enable option or off) can be adjusted in this menu. You can also reset this entire menu to factory default settings. See the following images showing the four cooling airflow profiles.

COOLING AIRFLOW PROFILE

- **Profile A** provides only an OFF delay of one (1) minute at 100% of the cooling demand airflow.

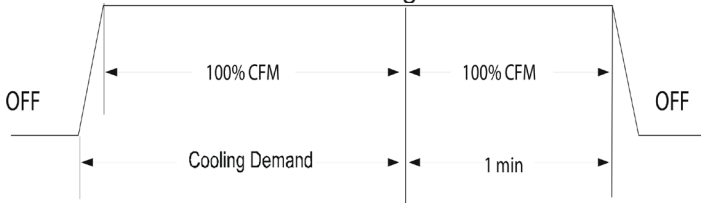

- **Profile B** ramps up to full cooling demand airflow by first stepping up to 50% of the full demand for 30 seconds. The motor then ramps to 100% of the required airflow. A one (1) minute OFF delay at 100% of the cooling airflow.

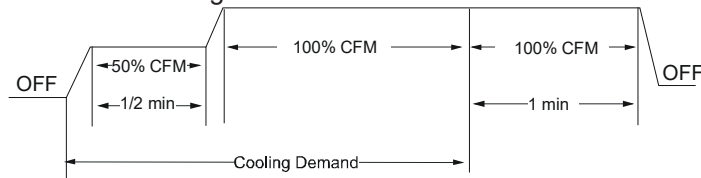

- **Profile C** ramps up to 82% of the full cooling demand airflow and operates there for approximately 7 1/2 minutes. The motor then steps up to the full demand airflow. Profile C also has a one (1) minute 100% OFF delay.

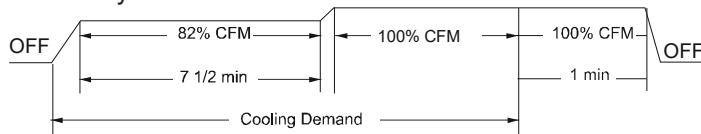

- **Profile D** (default) ramps up to 50% of the demand for 1/2 minute, then ramps to 82% of the full cooling demand airflow and operates there for approximately 7 1/2 minutes. The motor then steps up to the full demand airflow. Profile D has a 1/2 minute at 50% airflow OFF delay.

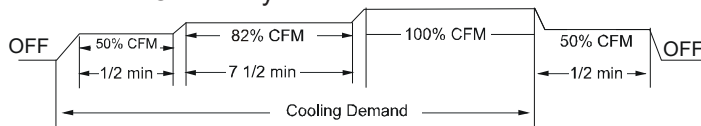

AIRFLOW TABLES

*1

1. At Cool and Heat Hi speed trim, *SXV906010* with **VC960804C, **VM970804C and *MVC800804C combination trim more than 5% settings are invalid. Trimmed up CFM makes miss matching error.
2. At Cool Hi speed trim, Other than the above, depending on the connected indoor unit, there are restrictions on the positive side Trim setting. If you want to change the Cool Airflow Trim to positive side, be sure to confirm the Airflow Trim restrictions in the latest indoor unit installation manual. The latest manual can be obtained from the website "PartnerLink(InfoFinderPlus/Literature)". [PartnerLink URL] <https://partnerlinkmarketing.goodmanmfg.com/goodman/info-finder-plus>

3. The Inverter system uses lower compressor speed and lower indoor unit CFM to optimize system performance. To obtain 100% CFM for home circulation, use full Trim setting instead of Int/ Low speed. This is recommended for applications with unusually cold return temperatures such as basements.

DEHUMIDIFICATION SELECT

Dehumidification requires a thermostat capable of reading the indoor humidity level from the thermostat and allows the user to set a dehumidification target based on these settings.

The thermostat controls the humidity level of the conditioned space using the cooling system. Dehumidification is engaged whenever a cooling demand is present and structural humidity levels are above the target level. When this condition exists, the circulating fan output is reduced, increasing system run time, over cooling the evaporator coil and ultimately removing more humidity from the structure than if only in cooling mode.

The thermostat may also allow for an additional overcooling limit setting depending on the thermostat utilized. This allows the cooling system to further reduce humidity by lowering the temperature below the cooling setpoint in an attempt to better achieve desired humidity levels.

When Dehumidification mode exists, the circulating fan output is reduced, increasing system run time, over cooling the evaporator coil and ultimately removing more humidity from the structure than if only in cooling mode.

The system can have Dehumidification operation in setting "Standard", "A", "B" or "C" of "dehumidify with cooling" menu based on dehumidification demand.

Setting "Standard" allows for the widest compressor operation range with lower CFM than Cooling mode.

In the Enhanced Dehumidification (setting A, B and C) the indoor airflow is lower than Standard Dehumidification (Standard).

Setting "A" allows for the same compressor operation range as standard Dehumidification with lower CFM than standard dehumidification (Standard).

Setting "B" limits compressor operation range and keeps high dehumidification capacity.

In setting "C" the system runs fixed at 100% compressor and airflow. See Figure 1.

NOTE: IN HIGH HUMIDITY ENVIRONMENTS, SWEATING ON SUPPLY DUCTS, CASED COILS OR AIR HANDLER CABINETS CAN BECOME AN ISSUE IN ENHANCED DEHUMIDIFICATION OPERATION. IT IS STRONGLY RECOMMENDED COVERING THEN WITH 2" FIBERGLASS INSULATION FOR THESE INSTALLATIONS.

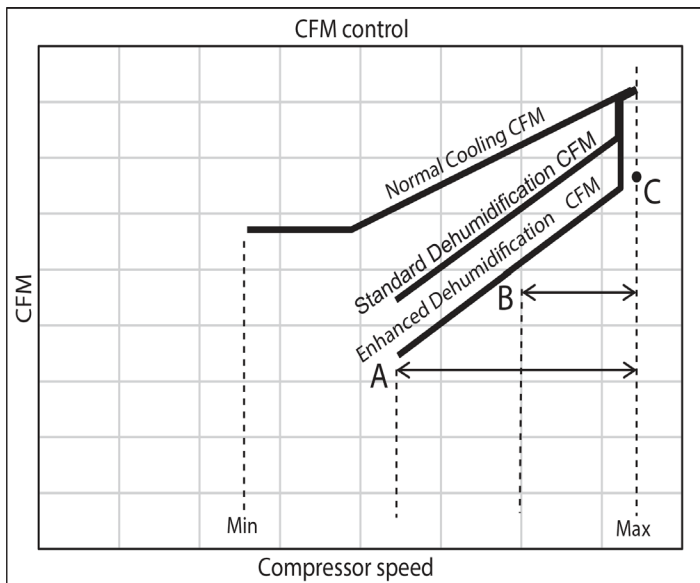

FIGURE 1

**MAX COMPRESSOR RPS FOR COOLING/HEATING
(SELECTED RPS/ RPS RANGE)**

Max compressor speed at which the outdoor unit will operate can be changed through the control board seven segment displays or the CoolCloud mobile app.

Max compressor speed can be changed to get the required capacity or efficiency.

Once the maximum speed is set, the system operates between the set maximum speed and default low speed.

When determining the appropriate compressor speed for cooling and heating, in the "RPS Range For Cooling/ Heating" menu select the range that contains the desired value.

(Then, after pressing the Apply Changes button, leave the Device setting menu and enter the this menu again. Otherwise, the changed settings will not be reflected.)

Next, in the "Selected RPS for Cooling/Heating" menu, select the desired RPS within the displayed range.

AIR CONDITIONER ADVANCED FEATURE MENU

AIR CONDITIONER(AC) / FAULT CODE HISTORY		
SUBMENU ITEM	INDICATION/USER MODIFIABLE OPTIONS	COMMENTS
ALL	(The Active and History Fault codes are displayed.)	Active fault code and up to 6 fault code histories.
ACTIVE	(The Active Fault codes are displayed.)	Active fault code only.
HISTORY	(The History Fault codes are displayed.)	Up to 6 fault code histories.
REFRESH	N/A	Selecting this menu will refresh the display.

AIR CONDITIONER(AC) / CONFIGURATION INFO		
SUBMENU ITEM	INDICATION/USER MODIFIABLE OPTIONS	COMMENTS
HVAC DEVICE	AIR CONDITIONER(AC)	The type of HVAC Device.
FIRMWARE VERSION	**	Specific number associated with the control software.
MODEL NUMBER	*SXV906010*	This number match the model name found on the serial plate.
SERIAL NUMBER	*****	This number match the serial number found on the serial plate.

AIR CONDITIONER(AC) / DEVICE STATUS		
SUBMENU ITEM	INDICATION(Units)	COMMENTS
COOL CAPACITY REQUEST	%	The request for cooling. 0% means the system is off. All other values mean the system is running.
DEHUMIDIFICATION REQUEST	%	Request for dehumidification. 0% means dehumidification is not being requested. All other values mean dehumidification is being requested.
OUTDOOR FAN SPEED	RPM	Current speed of the outdoor fan in rotations per minute.
REQUESTED AIRFLOW	CFM	This is the airflow the indoor unit will try to deliver while the unit is active.
REPORTED AIRFLOW	CFM	Indoor airflow (in cubic feet per minute) as reported by the indoor unit.
BOOST MODE	OFF or ON	If this feature is available and enabled, an inverter can ramp the compressor above default speeds to increase capacity. This shows if the feature is active or inactive. To check if this function is enabled, find the Boost Mode Enable item in the setting for this unit.

AIR CONDITIONER(AC) / SENSOR DATA		
SUBMENU ITEM	INDICATION(Units)	COMMENTS
OUTDOOR TEMP	F	Displays the outdoor air temperature.
LIQUID LINE TEMP	F	Displays the outdoor liquid temperature.
DISCHARGE TEMP	F	Displays the outdoor discharge temperature.
SUCTION PRESSURE	PSI	Displays the pressure of taken slightly upstream of the suction accumulator.

A representative menu is posted. Item names and setting value are subject to change.

AIR CONDITIONER ADVANCED FEATURE MENU

AIR CONDITIONER(AC) / DEVICE SETTING		
SUBMENU ITEM	INDICATION(Units)	COMMENTS
BOOST MODE ENABLE	OFF or ON	BOOST MODE is ON by default. See BOOST MODE section of this manual for more details.
BOOST TEMP	Always Active or 70F to 105F in increments	If enabled, when the ambient outdoor temperature is greater than this selected value, boost mode will be operational. Below this temperature the mode will not function. There is also an option to keep boost mode continuously enabled.
INDOOR/OUTDOOR HEIGHT DIFFERENCE	Both Units at Same Level, Outdoor Unit is Lower, or Indoor Unit is Lower	If the outdoor & indoor units are within +/- 15 ft. vertical distance, select SAME LEVEL. If the outdoor unit is more than 15 ft. below the indoor unit, select OUTDOOR LOWER. If the outdoor unit is more than 15 ft. above the indoor unit, select INDOOR LOWER.
RESET FOR SYSTEM SETUP	NO or YES	Selecting yes will reset any system setting to their factory defaults.
SYSTEM VERIFICATION TEST	OFF or ON	System Verification Test must be run after installation. This is approximately a 5-15 minute test. If operation mode is set to COOL mode, the system will enter CHARGE mode upon completion, otherwise it will stop.
PUMP DOWN	OFF or ON	Enter PUMP DOWN Mode. This procedure runs the equipment for approximately 15 minutes and allows accumulation of refrigerant at the outdoor unit for purposes of removing & replacing the indoor unit or outdoor unit.
ACTIVATE CHARGE MODE	OFF or ON	Enter Charging Mode. This allows for a steady system operation for a duration of approximately 1 hour to allow for refrigerant charging of the system via the charge port.
COOLING TRIM FACTOR(HIGH) ^{*1,2}	-15% to +15% in 5% increments	Select this airflow trim when inverter system is running high compressor speeds during a cooling cycle.
COOLING TRIM FACTOR(MID)	-15% to +15% in 5% increments, 20 30, Full(Max) ³	Select this airflow trim when inverter system is running mid-range (intermediate) compressor speeds during a cooling cycle.
COOLING TRIM FACTOR(LOW)	-15% to +15% in 5% increments, 20 30, Full(Max) ³	Select this airflow trim when inverter system is running low compressor speeds during a cooling cycle.
COOLING AIRFLOW PROFILE	A, B, C, or D	If it is desirable to quickly ramp up the indoor airflow select profile A. If it is desirable to reach nominal airflow quickly, but a slower ramp up time is required, select profile B. If dehumidification is required immediately when cooling mode begins select profile C. If a slower airflow ramp up / ramp down time is required in addition to dehumidification select profile D.
BLOWER ON DELAY-COOLING	5, 10, 20 or 30 Seconds	Delay between compressor turning on and indoor blower turning on during a cooling cycle.
BLOWER OFF DELAY-COOLING	30, 60, 90 or 120 Seconds	Delay between compressor shutting off and the indoor blower shutting off after a cooling cycle.
DEHUMIDIFICATION ENABLE ^{*4}	Standard, OFF, A, B or C	Selecting "OFF" disables dehumidification selecting "Standard", "A", "B" or "C" enables dehumidification.
RESET COOLING SETTINGS	NO or YES	Selecting yes will reset any cooling setting to their factory defaults.
RPS RANGE FOR COOLING	**.* to *.* RPS,...(Total 5 Ranges)	When determining the appropriate compressor speed for cooling, select the range that contains the desired value. The Selected RPS for Cooling menu is where you will select your desired value within this selected range.
SELECTED RPS FOR COOLING	**.* RPS	This value will be a number inside the RPS Range for Cooling. If you'd like to select a RPS from a different range, you must change the RPS Range for Cooling setting first, then restart the device setting page
RESET FAULT HISTORY	NO or YES	Selecting yes will clear the fault histories of device.

A representative menu is posted. Item names and setting value are subject to change.

*1 At Cool and Heat Hi speed trim, *SXV906010* with **VC960804C, **VM970804C and *MVC800804C combination trim more than 5% settings are invalid. Trimmed up CFM makes miss matching error.

*2 Other than the above, depending on the connected indoor unit, there are restrictions on the positive side Trim setting.

If you want to change the Cool Airflow Trim to positive side, be sure to confirm the Airflow Trim restrictions in the latest indoor unit installation manual. The latest manual can be obtained from the website "PartnerLink(InfoFinderPlus/Literature)".

[PartnerLink URL]

<https://partnerlinkmarketing.goodmanmfg.com/goodman/info-finder-plus>

*3 The Inverter system uses lower compressor speed and lower indoor unit CFM to optimize system performance.

To obtain 100% CFM for home circulation, use full Trim setting instead of Int/Low speed.

This is recommended for applications with unusually cold return temperatures such as basements.

*4 Please refer to the page of "DEHUMIDIFICATION SELECT " for details of this function.



WARNING

HIGH VOLTAGE!
Disconnect ALL power before servicing or installing this unit. Multiple power sources may be present. Failure to do so may cause property damage, personal injury or death.

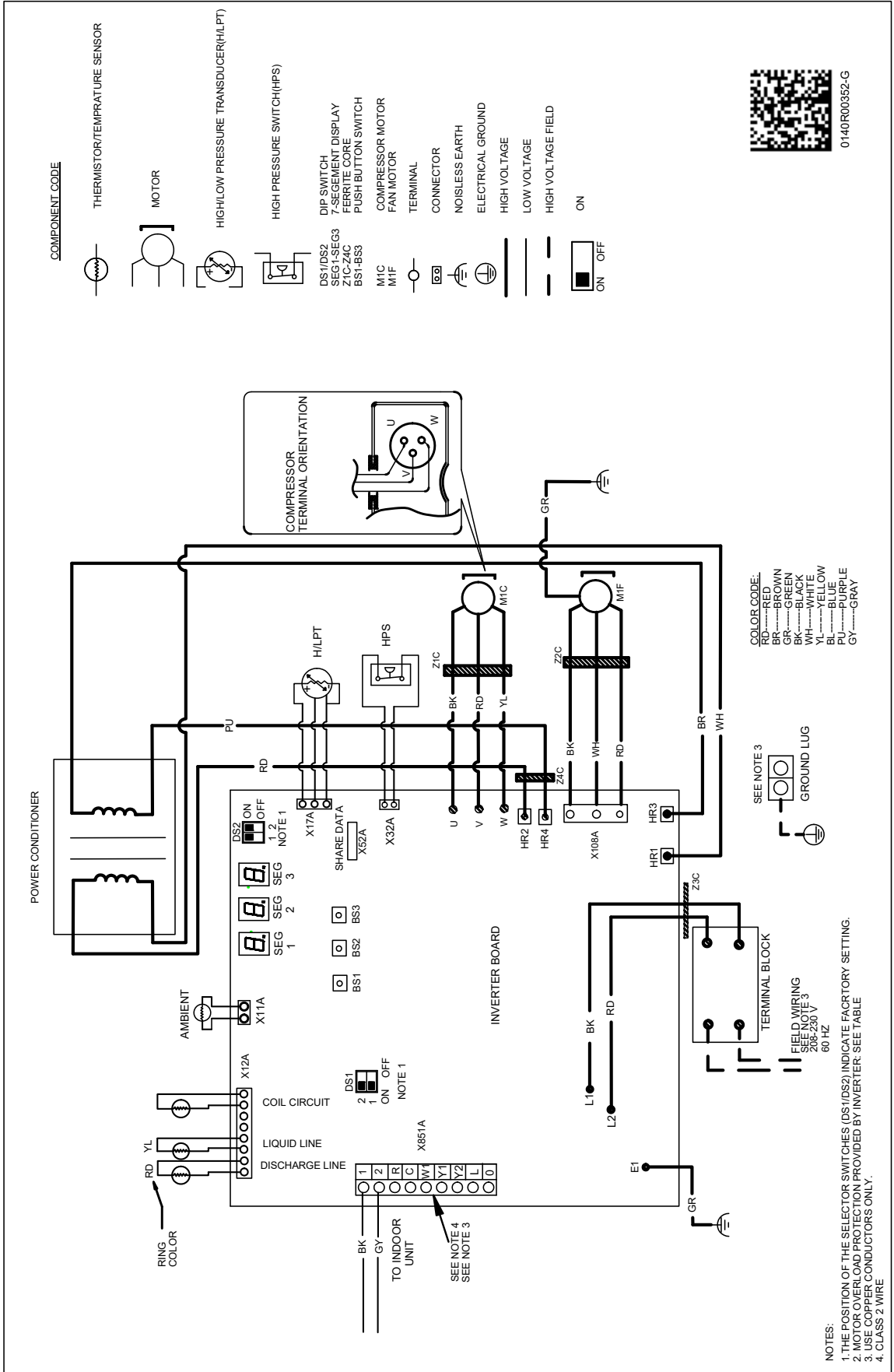

Wiring is subject to change. Always refer to the wiring diagram on the unit for the most up-to-date wiring.

WARNING

HIGH VOLTAGE!
Disconnect ALL power before servicing or installing this unit. Multiple power sources may be present. Failure to do so may cause property damage, personal injury or death.

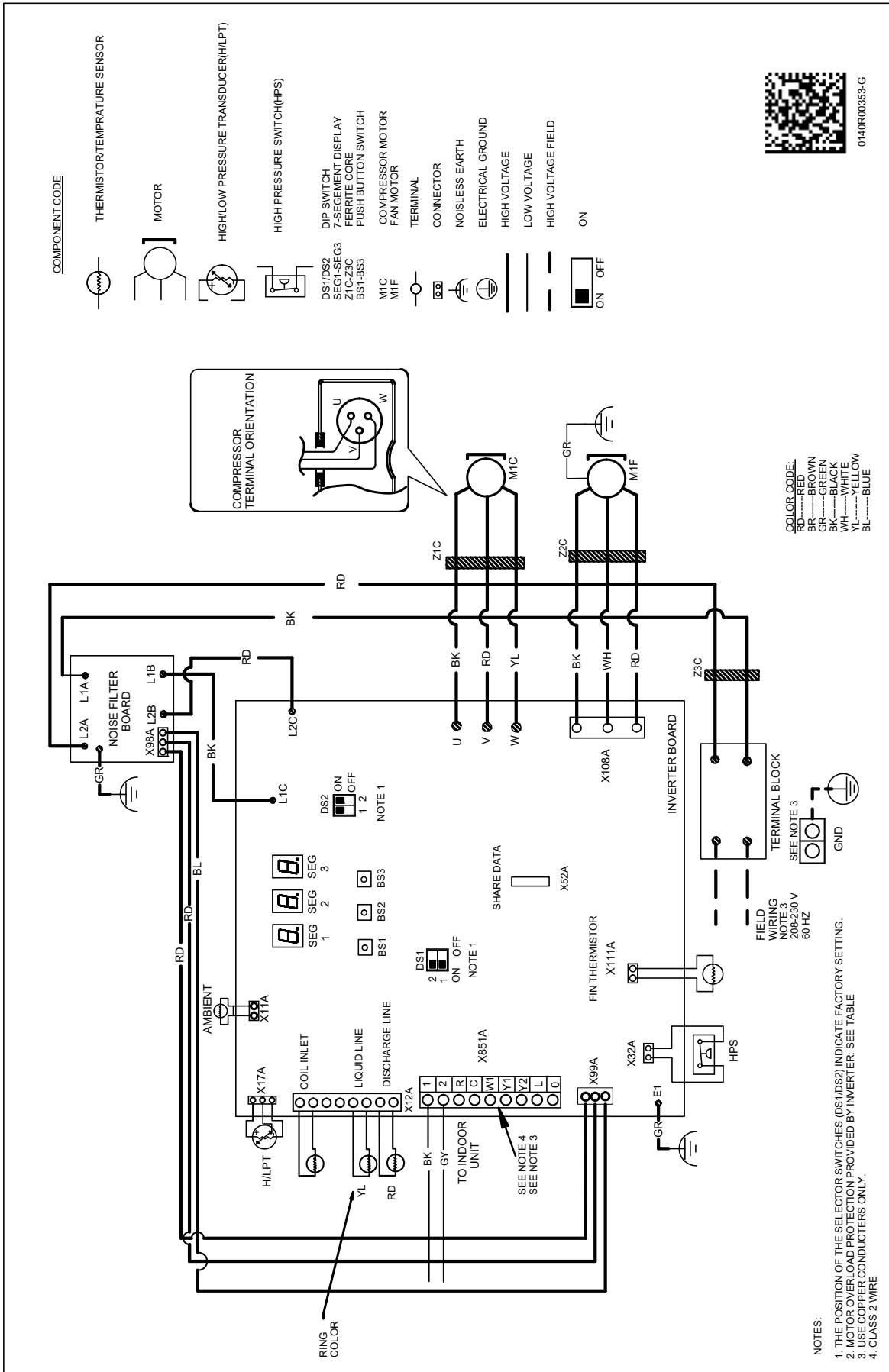

- NOTES:
1. THE POSITION OF THE SELECTOR SWITCHES (DS1/DS2) INDICATE FACTORY SETTING.
 2. MOTOR OVERLOAD PROTECTION PROVIDED BY INVERTER. SEE TABLE
 3. USE COPPER CONDUCTORS ONLY.
 4. CLASS 2 WIRE

Wiring is subject to change. Always refer to the wiring diagram on the unit for the most up-to-date wiring.

TESTING CAPACITOR RESISTANCE



WARNING

AVOID CONTACT WITH THE CHARGED AREA.

• NEVER TOUCH THE CHARGED AREA BEFORE CONFIRMING THAT THE RESIDUAL VOLTAGE IS 50 VOLTS OR LESS.

1. SHUT DOWN THE POWER AND LEAVE THE CONTROL BOX FOR 10 MINUTES.
2. MAKE SURE TO TOUCH THE EARTH GROUND TERMINAL TO RELEASE THE STATIC ELECTRICITY FROM YOUR BODY (TO PREVENT FAILURE OF THE PC BOARD).
3. MEASURE THE RESIDUAL VOLTAGE IN THE SPECIFIED MEASUREMENT POSITION USING A VOM WHILE PAYING ATTENTION NOT TO TOUCH THE CHARGED AREA.
4. IMMEDIATELY AFTER MEASURING THE RESIDUAL VOLTAGE, DISCONNECT THE CONNECTORS OF THE OUTDOOR UNIT'S FAN MOTOR. (IF THE FAN BLADE ROTATES BY STRONG WIND BLOWING AGAINST IT, THE CAPACITOR WILL BE CHARGED, CAUSING THE DANGER OF ELECTRICAL SHOCK.)

2-3 Ton

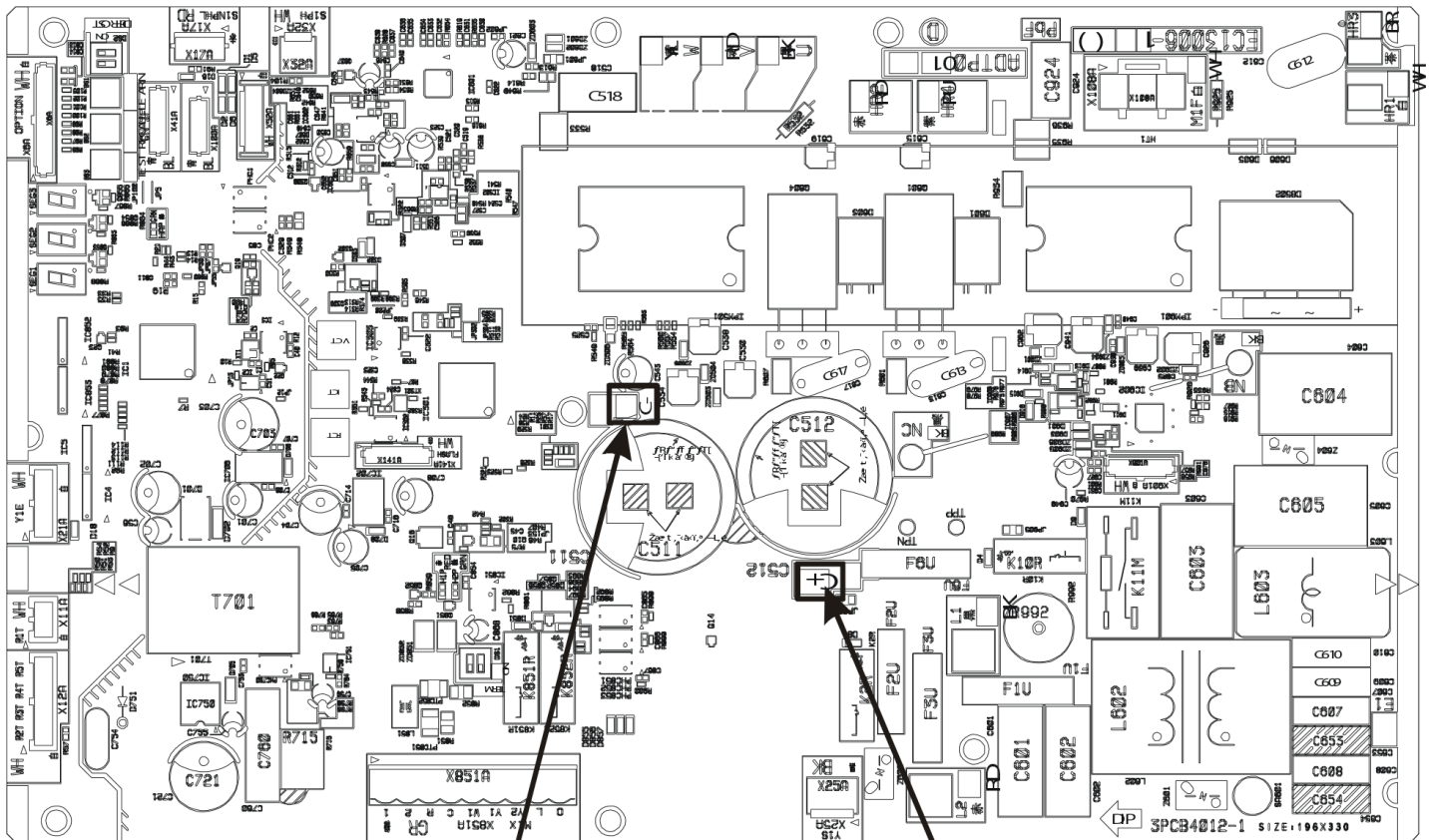

C-

Capacitor Voltage

C+

TESTING CAPACITOR RESISTANCE



WARNING

AVOID CONTACT WITH THE CHARGED AREA.

• NEVER TOUCH THE CHARGED AREA BEFORE CONFIRMING THAT THE RESIDUAL VOLTAGE IS 50 VOLTS OR LESS.

1. SHUT DOWN THE POWER AND LEAVE THE CONTROL BOX FOR 10 MINUTES.
2. MAKE SURE TO TOUCH THE EARTH GROUND TERMINAL TO RELEASE THE STATIC ELECTRICITY FROM YOUR BODY (TO PREVENT FAILURE OF THE PC BOARD).
3. MEASURE THE RESIDUAL VOLTAGE IN THE SPECIFIED MEASUREMENT POSITION USING A VOM WHILE PAYING ATTENTION NOT TO TOUCH THE CHARGED AREA.
4. IMMEDIATELY AFTER MEASURING THE RESIDUAL VOLTAGE, DISCONNECT THE CONNECTORS OF THE OUTDOOR UNIT'S FAN MOTOR. (IF THE FAN BLADE ROTATES BY STRONG WIND BLOWING AGAINST IT, THE CAPACITOR WILL BE CHARGED, CAUSING THE DANGER OF ELECTRICAL SHOCK.)

5 Ton

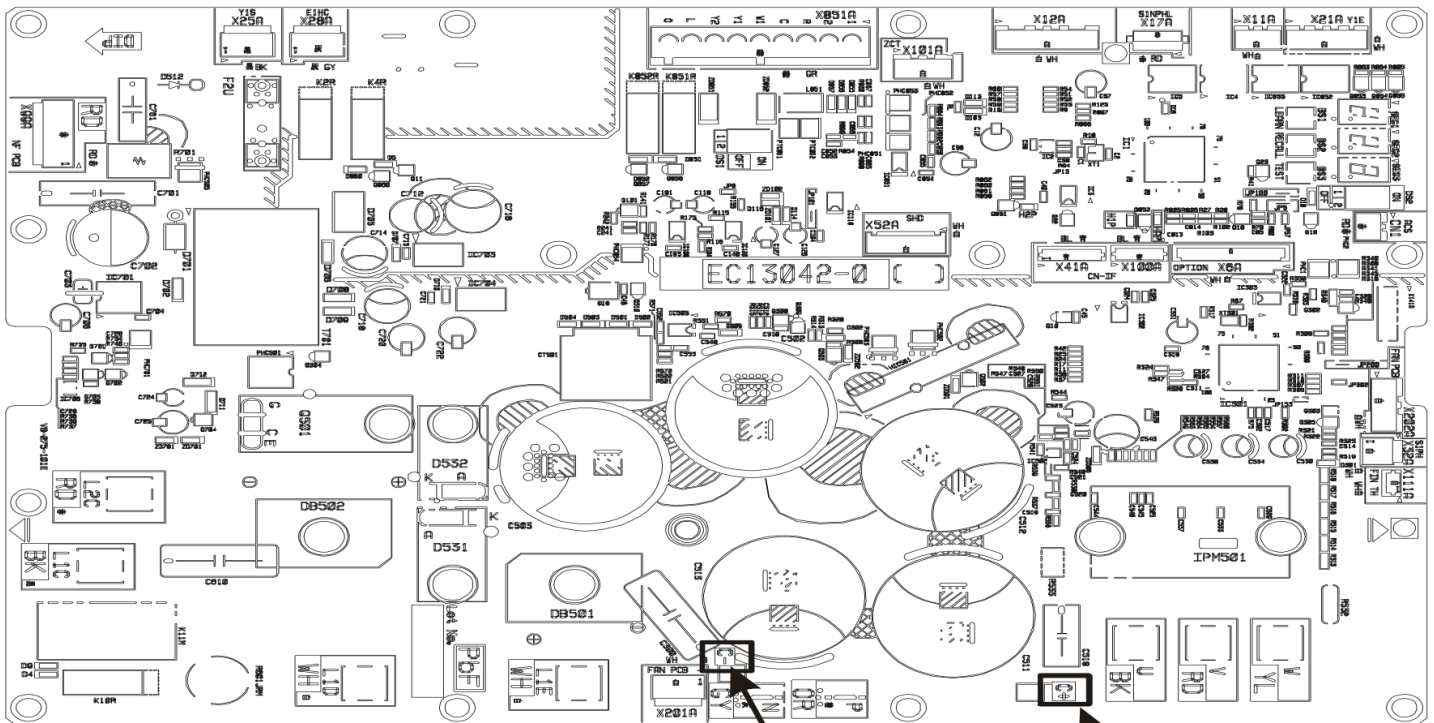

C-

C+

Capacitor Voltage

COOLING ANALYSIS CHART

POSSIBLE CAUSE X IN ANALYSIS GUIDE INDICATE "POSSIBLE CAUSE"	Comp discharge temp > 200F	Comp discharge temp < 105F	Comp discharge SH > 70F	Comp discharge SH < 20F	High pressure > 490psi	High pressure < 255psi	LSV SC > 12F	LSV SC < 4F	OD SSV SH > 20F	OD SSV SH < 4F	Low pressure > 185psi	Low pressure < 100psi	Requested % demand < Actual	Requested % demand > Actual	Repeated stop/start	Weak cooling	No switch cooling	Noise	Stop operation
	Liquid stop valve does not fully open	X		X		X		X		X			X		X	X	X		X
Gas stop valve does not fully open	X		X									X		X	X	X			
Line set restriction	X		X		X		X		X			X		X	X	X		X	
Line set length is too long									X			X		X	X	X		X	
Blocked filter-dryer	X		X		X		X		X			X		X	X	X		X	
OD EEV coil failure														X	X	X			X
OD EEV failure														X	X	X			
Check valve failure – Blocked	X		X		X			X	X			X		X	X	X			
High Pressure switch failure																			X
Pressure sensor failure	X										X	X		X	X	X			X
Discharge temp sensor failure	X	X	X	X									X	X	X	X			X
Coil temp sensor failure				X	X	X							X	X	X	X			X
Liquid temp sensor failure																			
Ambient temp sensor failure				X	X	X							X	X	X	X			
OD recirculation	X		X		X									X	X	X			X
ID recirculation		X		X						X		X	X	X	X	X			
Dirty OD Heat-exchanger	X		X		X									X	X	X			X
Dirty ID Heat-exchanger		X		X				X		X		X	X	X	X	X			
Outdoor Ambient temp is too high	X		X		X					X				X	X	X			X
Outdoor Ambient temp is too low		X		X		X	X					X	X	X	X	X			
ID suction temp is too high									X		X								
ID suction temp is too low		X		X					X		X		X	X	X	X			
Mixture of non-condensable gas	X		X		X				X	X		X		X	X	X			X
OD fan motor failure	X		X		X				X					X	X	X			X
Over charge	X	X	X	X	X		X			X			X			X			X
Under charge	X	X	X			X		X	X			X				X			X
Leak	X	X	X			X		X	X			X		X	X	X			X
TXV failure	X	X	X	X	X	X	X	X	X	X	X	X	X	X	X	X			
TXV is small	X		X		X				X			X							
TXV is big		X		X		X			X		X		X			X			
OD Control Board Failure																			X
ID Failure	X	X	X	X	X	X	X	X	X	X	X	X	X	X	X	X	X	X	X
Compressor failure	X	X	X			X					X			X	X	X			X
Cooling loop is not attached														X	X	X			
Cooling loop grease is not enough														X	X	X			
Compressor and Gas furnace are operating at the same time																			X
Low ID CFM		X		X						X		X	X	X	X	X			X

OUTDOOR NORMAL TEMPERATURE OPERATING RANGE: 67-115°F / INDOOR NORMAL TEMPERATURE OPERATING RANGE: 65-85°F

WARNING

AVOID CONTACT WITH THE CHARGED AREA.

- NEVER TOUCH THE CHARGED AREA BEFORE CONFIRMING THAT THE RESIDUAL VOLTAGE IS 50 VOLTS OR LESS.

1. SHUT DOWN THE POWER AND LEAVE THE CONTROL BOX FOR 10 MINUTES.
2. MAKE SURE TO TOUCH THE EARTH GROUND TERMINAL TO RELEASE THE STATIC ELECTRICITY FROM YOUR BODY (TO PREVENT FAILURE OF THE PC BOARD).
3. MEASURE THE RESIDUAL VOLTAGE IN THE SPECIFIED MEASUREMENT POSITION USING A VOM WHILE PAYING ATTENTION NOT TO TOUCH THE CHARGED AREA.
4. IMMEDIATELY AFTER MEASURING THE RESIDUAL VOLTAGE, DISCONNECT THE CONNECTORS OF THE OUTDOOR UNIT'S FAN MOTOR. (IF THE FAN BLADE ROTATES BY STRONG WIND BLOWING AGAINST IT, THE CAPACITOR WILL BE CHARGED, CAUSING THE DANGER OF ELECTRICAL SHOCK.)

TROUBLESHOOTING

ClimateTalk Fault Code	PCB LED Display	Transmitted ClimateTalk Message	Thermostat Fault	Probable Causes	Corrective Actions
12	E12	OD CTRL FAIL1	Indicates a general memory error.	<ul style="list-style-type: none"> High electrical noise Faulty control board 	<ul style="list-style-type: none"> Replace control board if necessary
13	E13	HI PRESSURE C (C = CRITICAL)	This error indicates the equipment is experiencing frequent high pressure faults.	<ul style="list-style-type: none"> Blocked/restricted condenser coil and/or lines Stop valve not completely open Overcharge Outdoor fan not running High pressure switch (HPS) inoperable Faulty TXV Faulty control board 	<ul style="list-style-type: none"> Check and clean condenser coil and/or lines Check the opening of stop valve, should be full open; Repair/replace if needed Check refrigerant charge level; Adjust if needed Check outdoor fan motor & wiring; Repair/replace if needed Check TXV; Replace if needed Replace control board if necessary
14	-	HI PRESSURE M (M = MINOR)	This error indicates the equipment is experiencing frequent high pressure faults. Control has determined continued operation is acceptable. This indicates they may be a problem with the equipment.	<ul style="list-style-type: none"> Blocked/restricted condenser coil and/or lines Stop valve not completely open Overcharge Outdoor fan not running High pressure switch (HPS) inoperable Faulty TXV Faulty control board 	<ul style="list-style-type: none"> Check and clean condenser coil and/or lines Check the opening of stop valve, should be full open; Repair/replace if needed Check refrigerant charge level; Adjust if needed Check outdoor fan motor & wiring; Repair/replace if needed Check TXV; Replace if needed Replace control board if necessary Check high pressure switch; Replace if necessary
15	E15	LOW PRESSURE C	This error indicates the equipment is experiencing frequent low pressure faults.	<ul style="list-style-type: none"> Stop valve not completely open Restriction in refrigerant lines Low refrigerant charge Refrigerant leak Low pressure sensor inoperable or not properly connected Indoor fan motor not functioning correctly Faulty TXV Faulty control board 	<ul style="list-style-type: none"> Check the opening of stop valve, should be full open; Repair/replace if needed Check for restrictions in refrigerant line; Repair/replace if needed Check refrigerant charge level; Adjust if needed Test for system leaks using leak test procedure Check the connection to low pressure sensor; Repair/replace if needed Check TXV; Replace if needed Check indoor blower motor & wiring; Repair/replace if needed Replace control board if necessary
16	-	LOW PRESSURE M	This error indicates the equipment is experiencing frequent low pressure faults. Control has determined continued operation is acceptable. This indicates they may be a problem with the equipment.	<ul style="list-style-type: none"> Stop valve not completely open Restriction in refrigerant lines Low refrigerant charge Refrigerant leak Low pressure sensor inoperable or not properly connected Indoor fan motor not functioning correctly Faulty TXV Faulty control board 	<ul style="list-style-type: none"> Check the opening of stop valve, should be full open; Repair/replace if needed Check for restrictions in refrigerant line; Repair/replace if needed Check refrigerant charge level; Adjust if needed Test for system leaks using leak test procedure Check the connection to low pressure sensor; Repair/replace if needed Check TXV; Replace if needed Check indoor blower motor & wiring; Repair/replace if needed Replace control board if necessary
17	E17	COMPRESSOR FAIL	This error indicates the equipment is experiencing frequent compressor faults.	<ul style="list-style-type: none"> Stop valve not completely open The compressor wire is lost phase Compressor motor failure 	<ul style="list-style-type: none"> Check the opening of stop valve, should be full open; Repair/replace if needed Check the wire between control board and compressor Inspect compressor motor for proper function; Replace if necessary
18	E18	OD CTRL FAIL2	Indicates the control board may need to be replaced.	<ul style="list-style-type: none"> Outdoor fan motor not connected properly Faulty control board Noise 	<ul style="list-style-type: none"> Check wiring from Outdoor fan motor to control board; Repair if needed. Replace control board if necessary
19	E19	PCB OR FAN FAIL	This error indicates the equipment is experiencing frequent outdoor control board and/or motor faults.	<ul style="list-style-type: none"> Obstruction in fan rotation Outdoor fan motor not connected properly Outdoor fan not running Faulty control board Noise 	<ul style="list-style-type: none"> Check and clean grille or any debris Check wiring from Outdoor fan motor to control board; Repair if needed Check outdoor fan motor & wiring. Repair/replace if needed Replace control board if necessary
20	E20	EEV OPEN CKT	EEV coil is not connected.	<ul style="list-style-type: none"> Outdoor EEV coil is not connected. Faulty outdoor EEV coil. 	<ul style="list-style-type: none"> Check outdoor EEV coil connection. Repair/replace as needed.
21	E21	EEV CTRL FAIL	This error indicates the equipment is experiencing frequent low discharge superheat faults.	<ul style="list-style-type: none"> Thermistors inoperable or improperly connected Faulty TXV Faulty outdoor EEV coil Faulty outdoor EEV Over charge Faulty pressure sensor Faulty control board 	<ul style="list-style-type: none"> Check the connection to thermistors; Repair/replace if needed Check TXV; Replace/repair if needed Check outdoor EEV coil; Repair/replace if needed Check outdoor EEV; Replace/repair if needed Check refrigerant charge level; Adjust if needed Check pressure sensor; Repair/replace if needed Replace control board if necessary

TROUBLESHOOTING

ClimateTalk Fault Code	PCB LED Display	Transmitted ClimateTalk Message	Thermostat Fault	Probable Causes	Corrective Actions
22	E22	HI DISCH TEMP	This error indicates the equipment is experiencing frequent high discharge temperature faults. Discharge thermistor is not put on correct position.	<ul style="list-style-type: none"> Discharge thermistor inoperable or improperly connected Discharge thermistor is put on incorrect position or off Low refrigerant charge Overcharge Faulty compressor 	<ul style="list-style-type: none"> Check discharge thermistor resistance and connections; Repair/replace as needed Check discharge thermistor position Check refrigerant charge level; Adjust if needed Check the compressor; Repair/replace if needed
23	E23	DISCH TEMP FAIL	The control has detected that the Discharge Temperature Sensor is out of range.	<ul style="list-style-type: none"> Discharge thermistor inoperable or improperly connected 	<ul style="list-style-type: none"> Check discharge thermistor resistance and connections; Repair/replace as needed
24	E24	HPS OPEN	The high pressure switch is open.	<ul style="list-style-type: none"> High pressure switch (HPS) inoperable 	<ul style="list-style-type: none"> Check resistance on HPS to verify operation; Replace if needed
25	E25	AIR SENSOR FLT	The outdoor air temperature sensor is open or shorted.	<ul style="list-style-type: none"> Faulty outdoor thermistor sensor or disconnect 	<ul style="list-style-type: none"> Inspect and test sensor; Replace sensor if needed
26	E26	PRESSURE SENSOR	The control determines that the pressure sensor is not reacting properly.	<ul style="list-style-type: none"> Low pressure sensor inoperable or not properly connected 	<ul style="list-style-type: none"> Check the connection to low pressure sensor; Repair/replace if needed
27	E27	COIL TEMP FAIL1	The control detects that the Outdoor Defrost Sensor is out of range.	<ul style="list-style-type: none"> Outdoor defrost thermistor inoperable or not properly connected 	<ul style="list-style-type: none"> Check the connection to OD defrost thermistor; Repair as needed
28	E28	COIL TEMP FAIL2	The control has detected that the Outdoor Coil Temperature Sensor is out of range.	<ul style="list-style-type: none"> Outdoor coil thermistor inoperable or not properly connected 	<ul style="list-style-type: none"> Check the connection to OD coil thermistor; Repair/replace if needed
29	E29	LIQ TEMP FAIL	The control has detected that the Liquid Temperature Sensor is out of range.	<ul style="list-style-type: none"> Liquid thermistor inoperable or not properly connected 	<ul style="list-style-type: none"> Check the connection to liquid thermistor; Repair/replace if needed
30	E30	OD CTRL FAIL3	Indicates the control board may need to be replaced.	<ul style="list-style-type: none"> Wiring to control board disconnected Faulty control board Noise 	<ul style="list-style-type: none"> Check wiring to control board; Repair as needed Replace control board if necessary
31	E31	HI LEAK CURRENT	The control has detected high leakage current (high voltage).	<ul style="list-style-type: none"> Improper ground Faulty compressor 	<ul style="list-style-type: none"> Check ground screws/lugs and wiring; Repair/replace if needed Check the compressor; Repair/replace if needed
32	E32	HI TEMP CTRL1	This error indicates the equipment is experiencing high temperature faults on the outdoor control board.	<ul style="list-style-type: none"> Ambient air conditions too high Cooling bracket screw(s) missing or not properly fastened (2-4 ton only) No or poor thermal grease coating between cooling plumbing and cooling bracket on control board (2-4 ton only) Outdoor fan low speed (5 ton only) No flow or limited flow through control board cooling circuit (potential restriction in line or low refrigerant) (2-4 ton only) Stop valve not completely open (2-4 ton only) 	<ul style="list-style-type: none"> Cycle power; re-try during usable ambient temperature range Verify cooling bracket screws in place and secure; Secure fasteners as needed (2-4 ton only) Check thermal grease inside cooling bracket on control board; Apply additional grease as needed Check outdoor fan motor & wiring; Repair/replace if needed (5 ton only) Check for restriction in line Check refrigerant charge level; Adjust if needed (2-4 ton only) Check the opening of stop valve, should be full open; Repair/replace if needed (2-4 ton only)
33	-	HI TEMP CTRL2	This error indicates the equipment is experiencing high temperature faults on the outdoor control board. Control has determined continued operation is acceptable. This indicates they may be a problem with the equipment.	<ul style="list-style-type: none"> Ambient air conditions too high Cooling bracket screw(s) missing or not properly fastened (2-4 ton only) No or poor thermal grease coating between cooling plumbing and cooling bracket on control board (2-4 ton only) Outdoor fan low speed (5 ton only) No flow or limited flow through control board cooling circuit (potential restriction in line or low refrigerant) (2-4 ton only) Stop valve not completely open (2-4 ton only) 	<ul style="list-style-type: none"> Cycle power; re-try during usable ambient temperature range Verify cooling bracket screws are in place and secure; Secure fasteners as needed (2-4 ton only) Check thermal grease inside cooling bracket on control board; Apply additional grease as needed Check outdoor fan motor & wiring; Repair/replace if needed (5 ton only) Check for restriction in line Check refrigerant charge level; Adjust if needed (2-4 ton only) Check the opening of stop valve - it should be fully open; Repair/replace if needed (2-4 ton only)
34	E34	CURRENT SPIKE	Board detected a high current condition. This indicates the potential for a short circuit.	<ul style="list-style-type: none"> Current spike in supply Stop valve not completely open The compressor wire is lost phase Faulty control board Faulty compressor 	<ul style="list-style-type: none"> Check power supply for in-rush current during start-up or steady state operation Check the opening of stop valve, should be full open; Repair/replace if needed Check the wire between control board and compressor Replace control board if necessary Check the compressor; Repair/replace if needed

TROUBLESHOOTING

ClimateTalk Fault Code	PCB LED Display	Transmitted ClimateTalk Message	Thermostat Fault	Probable Causes	Corrective Actions
35	E35	HIGH CURRENT	Board detected a high current condition.	<ul style="list-style-type: none"> Short circuit condition Stop valve not completely open Overcharge Faulty control board Faulty compressor 	<ul style="list-style-type: none"> Check installation clearances. Check the opening of stop valve, should be full open; Repair/replace if needed Check refrigerant charge level; Adjust if needed Replace control board if necessary Check the compressor; Repair/replace if needed.
36	E36	STARTUP ERROR	The control encountered an abnormal condition during the startup procedure.	<ul style="list-style-type: none"> Blocked/restricted condenser coil and/or lines The compressor wire is lost phase Inconsistent compressor load Faulty control board 	<ul style="list-style-type: none"> Check and clean condenser coil and/or lines Check the wire between control board and compressor Replace control board if necessary
37	E37	OD CTRL FAIL4	Indicates the control board may need to be replaced.	<ul style="list-style-type: none"> Outdoor fan motor not connected properly Faulty control board 	<ul style="list-style-type: none"> Check wiring from outdoor fan motor to control board; Repair if needed Replace control board if necessary
38	E38	COMP VOLTAGE	The control has detected a voltage related issue with the compressor.	<ul style="list-style-type: none"> High or low voltage from supply The compressor wire is lost phase Faulty control board 	<ul style="list-style-type: none"> Correct low/high line voltage condition; Contact local utility if needed Check the wire between control board and compressor Replace control board if necessary
39	E39	OD CTRL FAIL5	Indicates the control board may need to be replaced.	<ul style="list-style-type: none"> Thermistors inoperable or improperly connected Faulty control board 	<ul style="list-style-type: none"> Check the connection to thermistors; Repair/replace if needed Replace control board if necessary
40	E40	COMP MISMATCH	Control determines that its compressor requirement is different than the compressor capability.	<ul style="list-style-type: none"> Bluetooth® Shared Data Loader BTSDL01 not correct. Control board mismatch 	<ul style="list-style-type: none"> Check Bluetooth® Shared Data Loader BTSDL01 data vs. air conditioner model Verify control board size vs. air conditioner model; Replace control board if necessary
41	E41	LOW REFRIGERANT	The control has detected a low refrigerant condition.	<ul style="list-style-type: none"> Refrigerant leak Low refrigerant charge Thermistors inoperable or not properly connected 	<ul style="list-style-type: none"> Test for system leaks using leak test procedure Check refrigerant charge level; Adjust if needed Check the connection to thermistor; Repair/replace if needed
42	E42	LOW LINE VOLT	Control detects a low power supply voltage condition.	<ul style="list-style-type: none"> Low line voltage supply 	<ul style="list-style-type: none"> Check circuit breakers and fuses; Replace if needed Verify unit is connected to power supply as specified on rating plate Correct low line voltage condition; Contact local utility if needed
43	E43	HIGH LINE VOLT	Control detects a high power supply voltage condition.	<ul style="list-style-type: none"> High line voltage supply 	<ul style="list-style-type: none"> Verify unit is connected to power supply as specified on rating plate Correct high line voltage condition; Contact local utility if needed
44	E44	OP TEMP RANGE	The control detects the outdoor temperature outside recommended operational range. Unit may continue to operate normally.	<ul style="list-style-type: none"> Ambient air conditions too high or low 	<ul style="list-style-type: none"> Cycle power; re-try during usable ambient temperature range
45	E45	NO COOLING TEST	The control is unable to start the Cooling mode test because indoor heat has been turned on by thermostat. Please set thermostat to off position.	<ul style="list-style-type: none"> Heat provided by secondary heating source 	<ul style="list-style-type: none"> Turn off heater using thermostat before running AHRI mode
46	E46	NO HEATING TEST	The control is unable to start the Heating mode test because indoor heat has been turned on by thermostat. Please set thermostat to off position.	<ul style="list-style-type: none"> Heat provided by secondary heating source 	<ul style="list-style-type: none"> Turn off heater using thermostat before running AHRI mode
47	E47	NO SYS VER TEST	The control is unable to start the System Verification test because indoor heat has been turned on by thermostat. Please set thermostat to off position.	<ul style="list-style-type: none"> Heat provided by secondary heating source 	<ul style="list-style-type: none"> Turn off heater using thermostat before operation
48	E48	NO PUMP DOWN	The control is unable to enter the Pump Down Mode because indoor heat has been turned on by thermostat. Please set thermostat to off position.	<ul style="list-style-type: none"> Heat provided by secondary heating source 	<ul style="list-style-type: none"> Turn off heater using thermostat before operation
49	E49	NO CHARGE MODE	The control is unable to enter Charging Mode because indoor heat has been turned on by thermostat. Please set thermostat to off position.	<ul style="list-style-type: none"> Heat provided by secondary heating source 	<ul style="list-style-type: none"> Turn off heater using thermostat before operation
50	E50	LINE VOLT CTRL	This indicates there is a voltage issue on the control board. See service manual for troubleshooting information.	<ul style="list-style-type: none"> High or low voltage from supply Faulty control board 	<ul style="list-style-type: none"> Correct low/high line voltage condition; Contact local utility if needed Replace control board if necessary
51	E51	OD COMM ERROR	This indicates potential communication issues have been detected by the outdoor control board.	<ul style="list-style-type: none"> Communication wiring disconnected 	<ul style="list-style-type: none"> Check communication wiring; Repair as needed
52	-	COMP FAIL MINOR	This error indicates the equipment is experiencing frequent compressor faults. Control has determined continued operation is acceptable. This indicates they may be a problem with the equipment.	<ul style="list-style-type: none"> Stop valve not completely open The compressor wire is lost phase Compressor motor failure 	<ul style="list-style-type: none"> Check the opening of stop valve, should be full open; Repair/replace if needed Check the wire between control board and compressor Inspect compressor motor for proper function; Replace if necessary

(*1) NETWORK COMMUNICATION ERROR (REFER TO "NETWORK TROUBLESHOOTING")

TROUBLESHOOTING

ClimateTalk Fault Code	PCB LED Display	Transmitted ClimateTalk Message	Thermostat Fault	Probable Causes	Corrective Actions
53	-	PCB PR FAN MIN	This error indicates the equipment is experiencing frequent outdoor control board and/or motor faults. Control has determined continued operation is acceptable. This indicates there may be a problem with the equipment.	<ul style="list-style-type: none"> Obstruction in fan rotation Outdoor fan motor not connected properly Outdoor fan not running Faulty control board Noise 	<ul style="list-style-type: none"> Check and clean grille of any debris Check wiring from outdoor fan motor to control board; Repair if needed Check outdoor fan motor & wiring; Repair/replace if needed Replace control board if necessary
54	-	EEV MINOR	This error indicates the equipment is experiencing frequent low discharge superheat faults. Control has determined continued operation is acceptable. This indicates they may be a problem with the equipment.	<ul style="list-style-type: none"> Thermistors inoperable or improperly connected Faulty TXV Faulty control board 	<ul style="list-style-type: none"> Check the connection to thermistors; Repair/replace if needed Check TXV; Replace if needed Replace control board if necessary
55	-	HI DIS TEMP MIN	This error indicates the equipment is experiencing frequent high discharge temperature faults. Control has determined continued operation is acceptable. This indicates they may be a problem with the equipment.	<ul style="list-style-type: none"> Discharge thermistor inoperable or improperly connected Discharge thermistor is put on incorrect position or off Low refrigerant charge Overcharge Faulty compressor 	<ul style="list-style-type: none"> Check discharge thermistor resistance and connections; Repair/replace as needed Check discharge thermistor position Check refrigerant charge level; Adjust if needed Check refrigerant charge level; Adjust if needed Check the compressor; Repair/replace if needed
57	-	CL LOOP SWEAT	This indicates the control is sensing sweating on the cooling loop.	<ul style="list-style-type: none"> Refrigerant Leak Low refrigerant charge Faulty TXV Thermistors inoperable or improperly connected 	<ul style="list-style-type: none"> Test for system leaks using leak test procedure Check refrigerant charge level; Adjust if needed Check TXV; Replace if needed Check the connection to thermistors; Repair/replace if needed
B0	Eb0	NO ID AIRFLOW	The estimated airflow from indoor subsystem is near to 0 CFM.	<ul style="list-style-type: none"> Failed indoor blower motor Indoor fan motor not properly connected Too much static pressure 	<ul style="list-style-type: none"> Check ID fan motor wiring and connectors; Repair/replace if needed Check ID fan motor; Replace if needed
B9	Eb9	LOW ID AIRFLOW	Estimated airflow from motor is lower than the airflow requirement.	<ul style="list-style-type: none"> Failed indoor blower motor Indoor fan motor not properly connected Too much static pressure 	<ul style="list-style-type: none"> Check ID fan motor wiring and connectors; Repair/replace if needed Check ID fan motor; Replace if needed
D0	Ed0	NO NET DATA	Control board does not have the necessary data for it to properly perform its functions.	<ul style="list-style-type: none"> Air conditioner is wired as part of a communicating system and integrated control module does not contain any shared data. 	<ul style="list-style-type: none"> Replace control board if necessary Re-write shared data using Bluetooth® Shared Data Loader BTSDL01.
D1	Ed1	INVALID DATA	Control board does not the appropriate data needed to properly perform its functions.	<ul style="list-style-type: none"> Air conditioner is wired as part of a communicating system and integrated control module contains invalid shared data or network data is invalid for the integrated control module. 	<ul style="list-style-type: none"> Replace control board if necessary Re-write shared data using Bluetooth® Shared Data Loader BTSDL01.
D2	Ed2	INVALID SYSTEM	The airflow requirement is greater than the airflow capability of the indoor subsystem.	<ul style="list-style-type: none"> Air conditioner/heat pump is wired as part of a communicating system and outdoor unit requires airflow greater than indoor unit's airflow capability Shared data is incompatible the system or missing parameters Communication wiring has loose connection. 	<ul style="list-style-type: none"> Verify shared data is correct for your specific model; Repopulate data if required Check communication wiring. Repair as needed.
D3	Ed3	INVALID CONFIG	There is a mismatch between the shared data and the control physical hardware.	<ul style="list-style-type: none"> Shared data sent to integrated control module does not match hardware configuration. 	<ul style="list-style-type: none"> Verify shared data is correct for your specific model; Repopulate data if required.
D4	Ed4	INVALID MC DATA	The Bluetooth® Shared Data Loader BTSDL01 data has been rejected.	<ul style="list-style-type: none"> Shared data on the Bluetooth® Shared Data Loader BTSDL01 has been rejected. 	<ul style="list-style-type: none"> Verify shared data is correct for your specific model; Repopulate data if required.
Items below are messages only displayed on the thermostat screen.					
11	E11	RUN SYS TEST	This test is required at startup. Installer should navigate to the ComfortNet User Menu, choose Air Conditioner, then EQUIP TEST and SYSYTEM TEST. Selecting ON will run the required test. Display will clear once testing is complete.	<ul style="list-style-type: none"> Incomplete SYSTEM TEST SYSTEM TEST is running 	<p>Run the SYSTEM START-UP TEST. (See the installation manual of the outdoor unit, "STEP3. SYSTEM START-UP TEST")</p>

NOTE: FOR SERVICE INFORMATION RELATED TO THE BLUETOOTH® SHARED DATA LOADER BTSDL01 REFERENCED IN THIS MANUAL, PLEASE REFER TO THE INSTALLATION INSTRUCTIONS FOR THE BTSDL01 AT WWW.COOLCLOUDHVAC.COM/LOADERUSERGUIDE.

NETWORK TROUBLESHOOTING

If a network communication error code has occurred, use the following steps to help troubleshoot the system. (For network communication error codes, refer to the table below and the tables of error codes for outdoor unit and indoor unit.)

After any wiring changes have been made or DS1 dip switches on the outdoor unit control board have been changed, apply power to the system and see if the error codes have cleared.

1. Confirm low voltage wiring is correct per installation instructions. Check for miswiring. (i.e. Terminal 1 and 2 is reversed.)

NOTE: A REMOVABLE PLUG CONNECTOR IS PROVIDED WITH THE CONTROL TO MAKE THERMOSTAT WIRE CONNECTIONS. THIS PLUG MAY BE REMOVED, WIRE CONNECTIONS MADE TO THE PLUG, AND REPLACED. IT IS STRONGLY RECOMMENDED THAT YOU DO NOT CONNECT MORE THAN TWO WIRES INTO A SINGLE TERMINAL IN THE FIELD BECAUSE THERE IS A RISK OF THE WIRES BECOMING LOOSE, WHICH MAY RESULT IN INTERMITTENT OPERATION.

2. Check wires for damage. (i.e. Broken wire at terminal, broken inside wire nuts or damaged cable between units.)

3. Perform continuity check on wires to make sure cable is OK. Replace the cable if necessary.
4. Change both dip switches of DS1 on the outdoor unit control board to the opposite position. See image below.

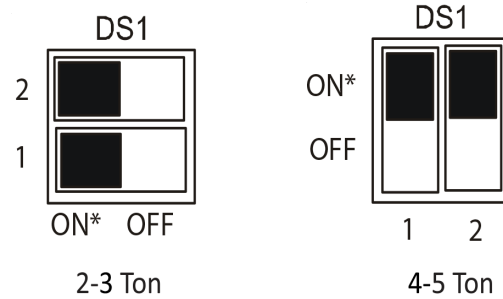

(*) Default factory setting

The integrated control module has some on board tools that can be used to troubleshoot the network. These tools are: red communications LED, green receive (Rx) LED, and the Learn button.

- Red communications LED - Indicates the status of the network. The table below indicates the LED status and the corresponding potential problem.
- Green receive LED - Indicates network traffic. The table below indicates the LED status and the corresponding potential problem.
- Learn button - Used to reset the network. Press the button for approximately 5 seconds to reset the network.

LED Color	LED Status	Indication	Probable Causes	Corrective Actions
Red Communications LED Outdoor unit control board: (H1P) Indoor unit control board: (H2P)	Off	Normal Condition	• None	• None
	1 Flash	Communications Failure	• Unknown packet is received • Communications failure	• Depress Learn button • Verify wiring connection
	2 Flash	Out-of-box reset	• Control power up • Learn button depressed	• None
Green Receive LED Outdoor unit control board: (H2P) Indoor unit control board: (H3P)	Off	No power Communications error	• No power to unit • Open fuse • Communication error	• Check circuit breakers and fuses; Reset/Replace if needed • Reset network by depressing Learn button • Check communication wires (Terminal 1/Terminal 2 wires); Replace if needed • Check for shorts in low voltage wiring.
	1 Steady Flash	No network found	• Broken/disconnected communication wire(s) • Unit is installed as a legacy/traditional system	• Check communication wires (Terminal 1/Terminal 2 wires); Replace if needed • Check installation type (legacy/traditional or communicating)
	Rapid Flashing	Normal network traffic	• Control is "talking" on network as expected	• None
	On Solid	Terminal 1/Terminal 2 mis-wire	• Terminal 1 and Terminal 2 wires reversed at indoor unit, thermostat, or outdoor unit • Short between Terminal 1 and Terminal 2 wires • Short between Terminal 1 or Terminal 2 two wires and Terminal C (24VAC) or Terminal R (24VAC, COM)	• Check communication wires (Terminal 1/Terminal 2 wires); Replace if needed

SETTING THE MODE DISPLAY

MODE DISPLAY INTRODUCTION

A 3-digit display is provided on the printed circuit board (PCB) as a backup tool to the thermostat for reading faults, fault history, monitoring and setting up the unit. Follow the information provided in this section to learn how to use the mode display.

DISPLAY

The display consists of 3 digits.

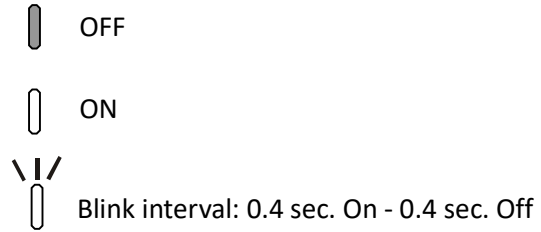
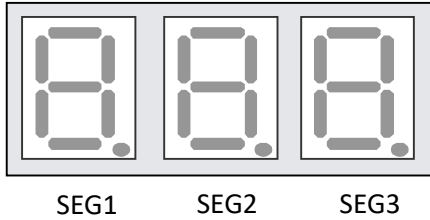

DISPLAY BUTTON LAYOUT

The display buttons shown can be used to navigate and select items:

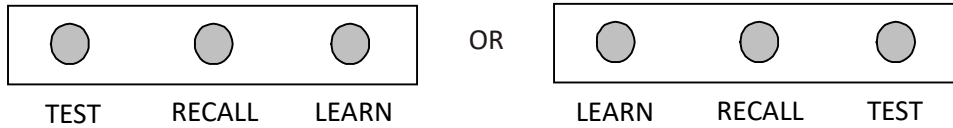

Examples of button layout are shown above. Identify correct display buttons on your unit PCB.

MODES

There are 5 modes which can be accessed using the setting display: FAULT CODE, FAULT HISTORY, MONITORING, SETTING MODE 1 and SETTING MODE 2.

To enter any of these modes, use the schemes shown in this section. Each mode has its own corresponding "Screen #" within the display itself which allows the user to navigate and use the features. (Example: The Fault Code is accessed and displayed from "Screen 0" of the 7-segment display. The Fault History is accessed and display using "Screen 1" of the display, etc.)

<u>MODE</u>	<u>FUNCTION</u>	<u>DISPLAY SCREEN #</u>
<i>Fault Code Display</i>	Present fault (if any).	0 (Default)
<i>Fault Code History</i>	6 Recent faults stored.	1
<i>Monitoring Mode</i>	*Monitors system values.	2
<i>Setting Mode 1</i>	*Can change system settings	3
<i>Setting Mode 2</i>	*Can change system settings.	4

**See tables at the end of this section.*

SETTING THE MODE DISPLAY

NAVIGATING THROUGH THE DISPLAY SCREENS

- SCREEN 0** The home or default screen on the display. This shows the most recent fault.
- SCREEN 1** To access, hold the RECALL button for 5 seconds at screen 0.
- SCREEN 2** To access, hold the RECALL button for 5 seconds at screen 1.
- SCREEN 3** To access, hold the RECALL button for 5 seconds at screen 2.
- SCREEN 4** To access, hold the RECALL and TEST buttons simultaneously for 5 seconds at screen 2.
- To return to SCREEN 0 of the display, press the LEARN button.

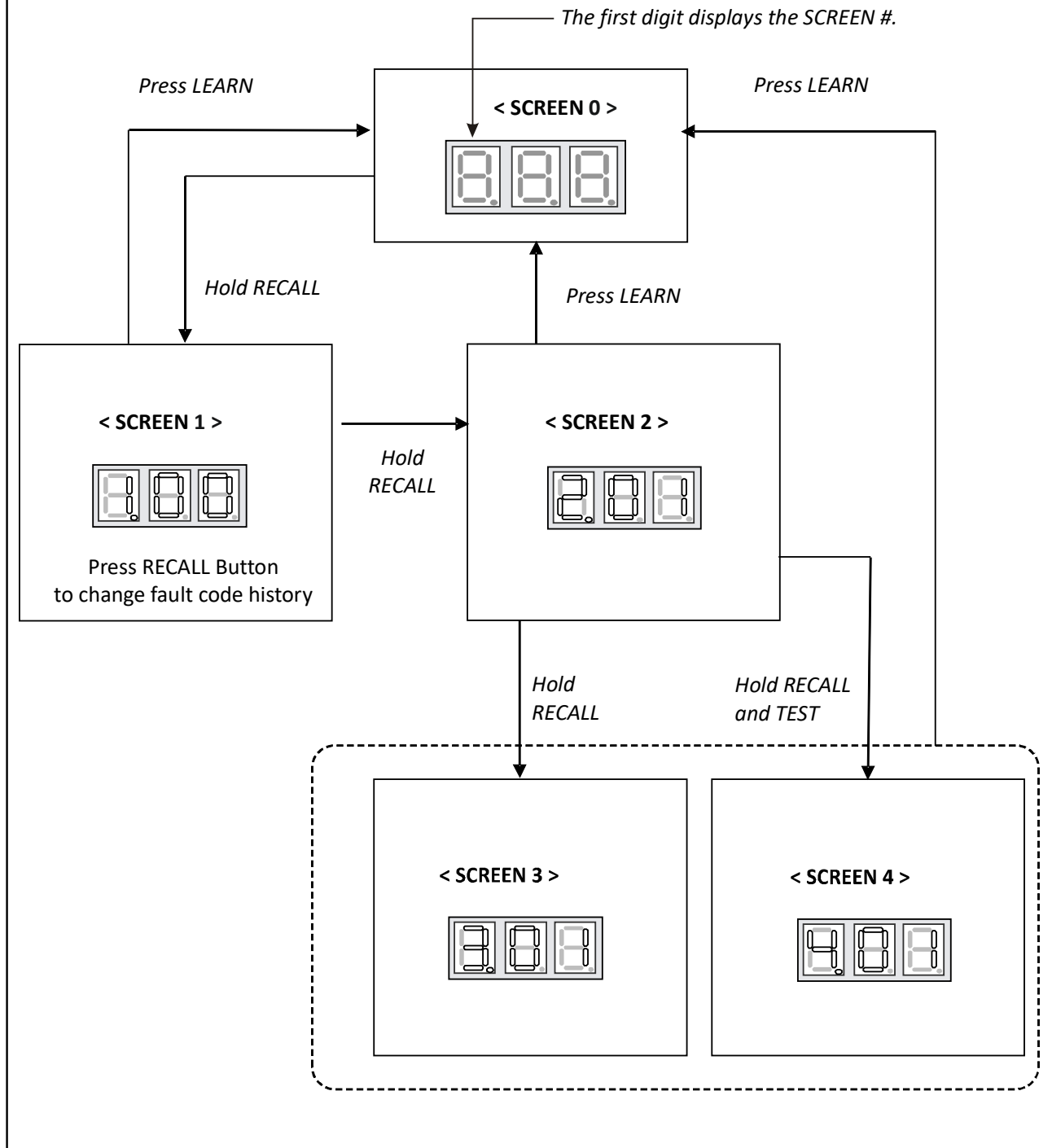

FAULT CODE HISTORY NAVIGATION

< SCREEN 1 >

This mode will allow the user to see the six most recent system faults.
For a list of the fault codes, please see the TROUBLESHOOTING tables in this document.

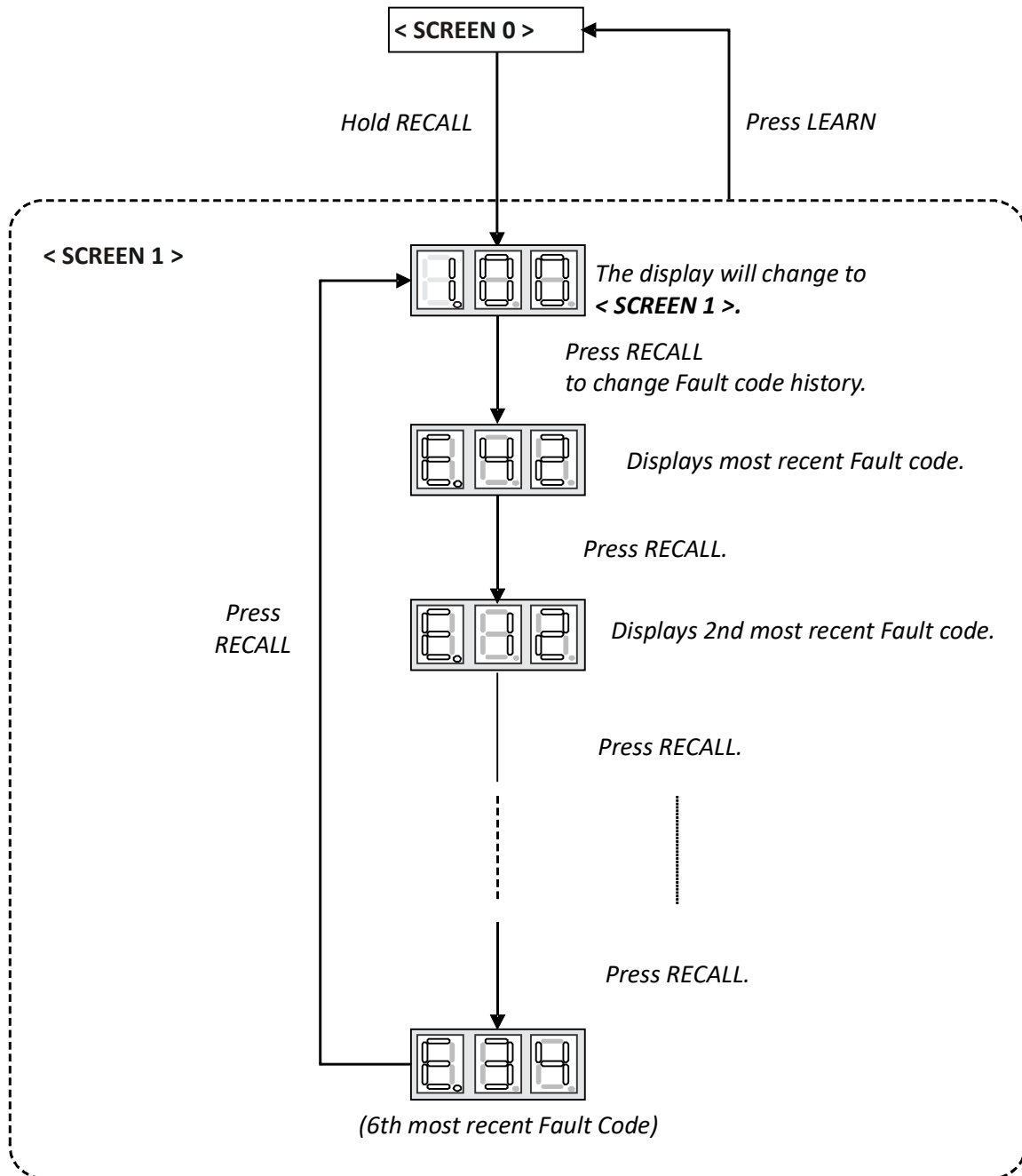

SETTING THE MODE DISPLAY

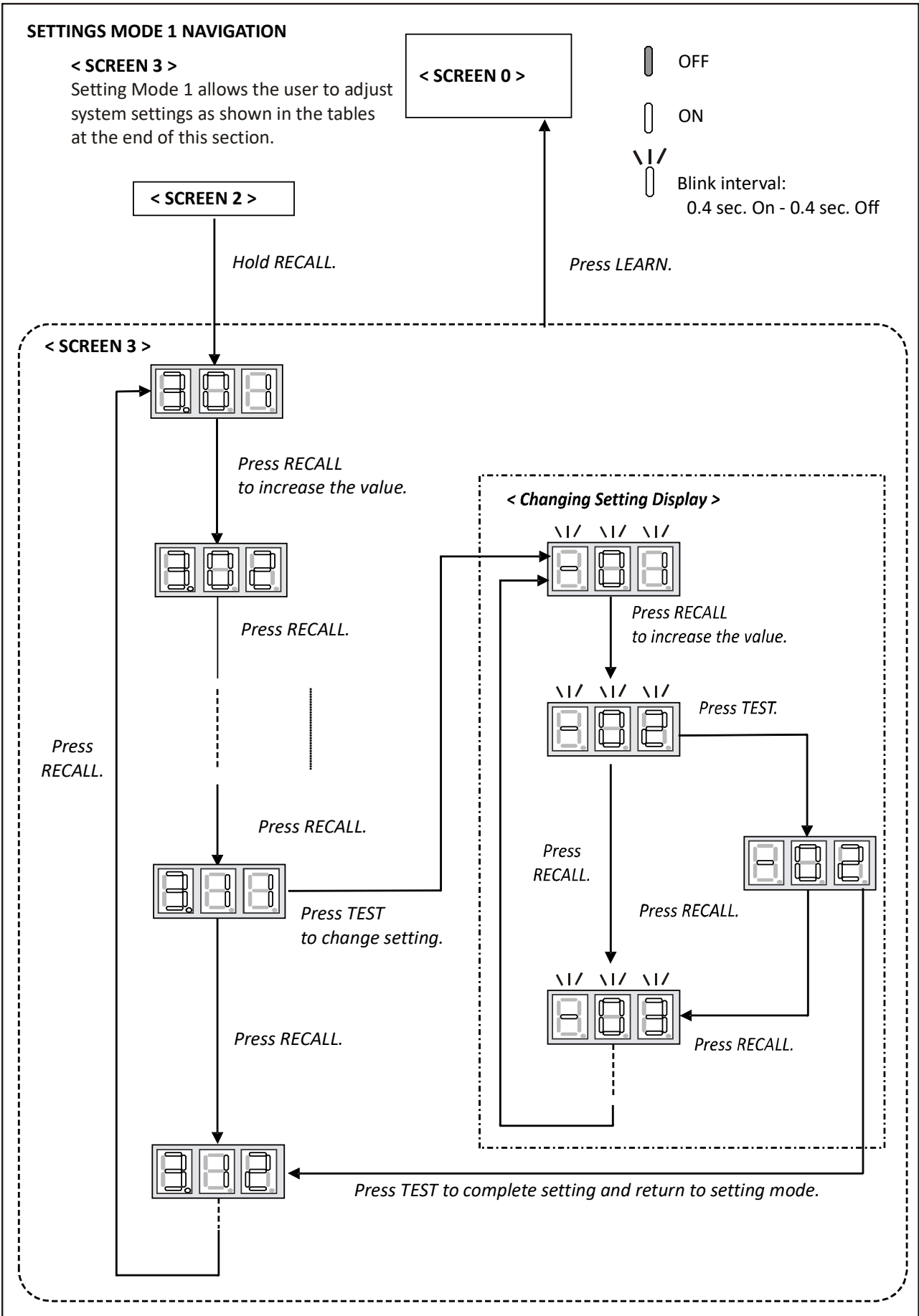

SETTING THE MODE DISPLAY

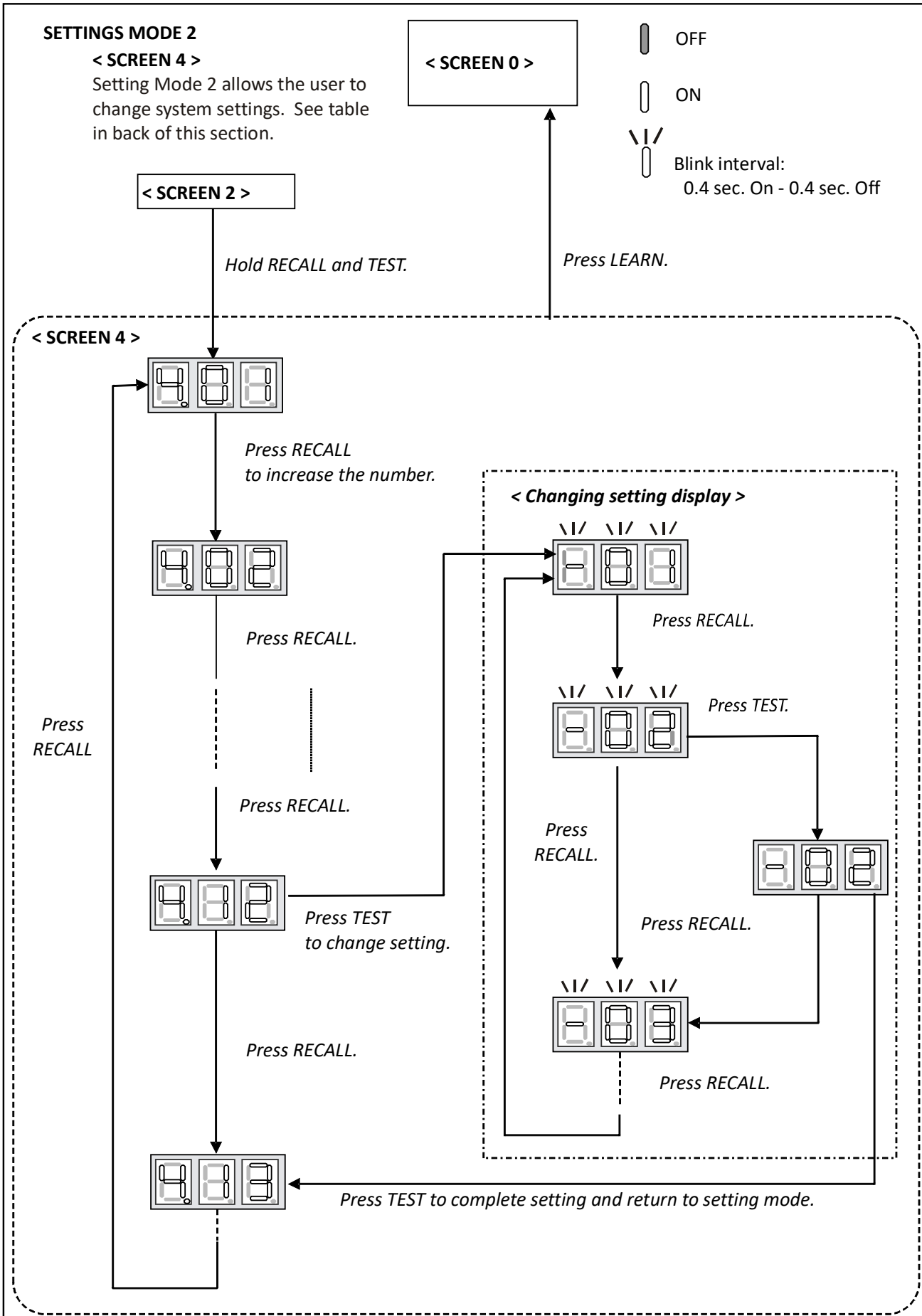

7-SEGMENT DISPLAY

SCREEN 0 (Display FAULT CODE)

Setting No.	Contents	Notes
1	Fault code (present)	

SCREEN 1 (Display FAULT CODES)

Setting No.	Contents	Notes
1	Fault code (latest)	Latest
2	Fault code (2nd)	2nd
3	Fault code (3rd)	3rd
4	Fault code (4th)	4th
5	Fault code (5th)	5th
6	Fault code (6th)	6th

SCREEN 2 (MONITOR MODE)

Setting No.	Contents	Notes
1	Compressor operation time	unit : hr (Multiply by 200.)
2	Operation code	0: Stop 1: Cooling Start-up 2: Heating Start-up 3: Oil Return Operation 4: Heating Operation 5: Defrost Operation 6: Cooling Operation
3	Compressor Reduction Mode	0:OFF,1:ON
4	% demand	unit : % (Cut off the decimal first place.)
5	act % demand	unit : % (Cut off the decimal first place.)
6	Requested ID CFM	unit : CFM (Multiply by 10)
7	Reported ID CFM	unit : CFM (Multiply by 10)
8	Outdoor FAN RPM	unit : RPM (Multiply by 10)
9	Ta (Outdoor Air Temperature)	unit : F
10	Td (Discharge Temperature)	unit : F
11	Tm (Outdoor Coil Temperature)	unit : F
12	Tb (Defrost Sensor Temperature)	unit : F
13	TI (Liquid Temperature)	unit : F
14	Pressure Sensor	unit : PSI

7-SEGMENT DISPLAY

SCREEN 3 (SETTING MODE 1)

Setting No.	Contents	Setting	Installer/Service Man Notes
1	Cool Airflow Trim High ^{*1,*2}	0: -15% 2: -5% 4: 5% 6: 15% 1: -10% 3: 0% 5: 10%	
2	Cool Airflow Trim Int	0: -15% 3: 0% 6: 15% 9: Full (Max) ^{*3} 1: -10% 4: 5% 7: 20% 2: -5% 5: 10% 8: 30%	
3	Cool Airflow Trim Low	0: -15% 3: 0% 6: 15% 9: Full (Max) ^{*3} 1: -10% 4: 5% 7: 20% 2: -5% 5: 10% 8: 30%	
4	Cool Profile	0: A 1: B 2: C 3: D	
5	Cool Fan ON Delay	0: 5sec. 1: 10sec. 2: 20sec. 3: 30sec.	
6	Cool Fan OFF Delay	0: 30sec. 1: 60sec. 2: 90sec. 3: 120sec.	
7	Dehumidification Select ^{*4}	0: STD 2: A 4: C 1: OFF 3: B	
13	Airflow Trim Offset ^{*1,*2}	0: 0% 1: +2.5%	Used for additional trim setting by adding 2.5% to basic airflow trim setting. This setting affects all trim settings except +15% High (cooling or heating).
14	Zoning Selection	0: ON 1: OFF	
15	Circulation Selection	0: ON 1: OFF	

NOTE: Parameters as per factory setting are highlighted in bold and underlined.

*1 *SXV906010 with **VC960804C, **VM970804C and MVC800804C combination trim more than 5% settings are invalid.

Trimmed up CFM makes miss matching error.

*2 Depending on the connected indoor unit, there are restrictions on the positive side Trim setting.

If you want to change the Cool Airflow Trim to positive side, be sure to confirm the Airflow Trim restrictions in the latest indoor unit installation manual.

The latest manual can be obtained from the website "PartnerLink(InfoFinderPlus/Literature)".

[PartnerLink URL]

<https://partnerlinkmarketing.goodmanmfg.com/goodman/info-finder-plus>

*3 The Inverter system uses lower compressor speed and lower indoor unit CFM to optimize system performance.

To obtain 100% CFM for home circulation, use full Trim setting instead of Int/Low speed.

This is recommended for applications with unusually cold return temperatures such as basements.

*4 Please refer to the page of "DEHUMIDIFICATION SELECT" for details of this function.

SCREEN 4 (SETTING MODE 2)

Setting No.	Contents	Setting	Installer/Service Man Notes
1	Maximum Defrost Interval	0: 30min. 1: 60min. 2: 90min. 3: 120min.	
2	Set Maximum Current	N/A	Future Use
4	System Verification Test (System Test)	0: ON 1: OFF	
8	Pump Down	0: ON 1: OFF	
9	Charge Mode	0: ON 1: OFF	
10	Maximum Compressor RPS for Cooling	*	
12	BOOST MODE Selection	0: ON 1: OFF	
13	BOOST MODE Temperature	0: 105F , 1: 100F, 2: 95F, 3: 90F, 4: 85F, 5: 80F, 6: 75F, 7: 70F, 8: Always ON	

* Depends on tonnage. Can adjust compressor RPS in each 0.5 RPS.

NOTE: Parameters as per factory setting are highlighted in bold and underlined.

SPLIT SYSTEMS

AIR CONDITIONING AND HEAT PUMP HOMEOWNER'S ROUTINE MAINTENANCE RECOMMENDATIONS

*We strongly recommend a bi-annual maintenance checkup be performed before the heating and cooling seasons begin by a **qualified servicer**.*

REPLACE OR CLEAN FILTER

IMPORTANT NOTE: Never operate unit without a filter installed as dust and lint will build up on internal parts resulting in loss of efficiency, equipment damage and possible fire.

An indoor air filter must be used with your comfort system. A properly maintained filter will keep the indoor coil of your comfort system clean. A dirty coil could cause poor operation and/or severe equipment damage.

Your air filter or filters could be located in your furnace, in a blower unit, or in "filter grilles" in your ceiling or walls. The installer of your air conditioner or heat pump can tell you where your filter(s) are, and how to clean or replace them.

Check your filter(s) at least once a month. When they are dirty, replace or clean as required. Disposable type filters should be replaced. Reusable type filters may be cleaned.

You may want to ask your dealer about high efficiency filters. High efficiency filters are available in both electronic and non-electronic types. These filters can do a better job of catching small airborne particles.

COMPRESSOR

The compressor motor is hermetically sealed and does not require additional oiling.

MOTORS

Indoor and outdoor fan motors are permanently lubricated and do not require additional oiling.

CLEAN OUTSIDE COIL (QUALIFIED SERVICER ONLY)



WARNING

HIGH VOLTAGE!

DISCONNECT ALL POWER BEFORE SERVICING. MULTIPLE POWER SOURCES MAY BE PRESENT. FAILURE TO DO SO MAY CAUSE PROPERTY DAMAGE, PERSONAL INJURY OR DEATH.



Air must be able to flow through the outdoor unit of your comfort system. Do not construct a fence near the unit or build a deck or patio over the unit without first discussing your plans with your dealer or other qualified servicer. Restricted airflow could lead to poor operation and/or severe equipment damage.

Likewise, it is important to keep the outdoor coil clean. Dirt, leaves, or debris could also restrict the airflow. If cleaning of the outdoor coil becomes necessary, hire a qualified servicer. Inexperienced people could easily puncture the tubing in the coil. Even a small hole in the tubing could eventually cause a large loss of refrigerant. Loss of refrigerant can cause poor operation and/or severe equipment damage.

Do not use a condensing unit cover to "protect" the outdoor unit during the winter, unless you first discuss it with your dealer. Any cover used must include "breathable" fabric to avoid moisture buildup.

BEFORE CALLING YOUR SERVICER

- Check the thermostat to confirm that it is properly set.
- Wait 15 minutes. Some devices in the outdoor unit or in programmable thermostats will prevent compressor operation for awhile, and then reset automatically. Also, some power companies will install devices which shut off air conditioners for several minutes on hot days. If you wait several minutes, the unit may begin operation on its own.
- Check the electrical panel for tripped circuit breakers or failed fuses. Reset the circuit breakers or replace fuses as necessary.
- Check the disconnect switch near the indoor furnace or blower to confirm that it is closed.
- Check for obstructions on the outdoor unit. Confirm that it has not been covered on the sides or the top. Remove any obstruction that can be safely removed. If the unit is covered with dirt or debris, call a qualified servicer to clean it.
- Check for blockage of the indoor air inlets and outlets. Confirm that they are open and have not been blocked by objects (rugs, curtains or furniture).
- Check the filter. If it is dirty, clean or replace it.
- Listen for any unusual noise(s), other than normal operating noise, that might be coming from the outdoor unit. If you hear unusual noise(s) coming from the unit, call a qualified servicer.



CAUTION

TO AVOID THE RISK OF EQUIPMENT DAMAGE OR FIRE, INSTALL THE SAME AMPERAGE BREAKER OR FUSE AS YOU ARE REPLACING. IF THE CIRCUIT BREAKER OR FUSE SHOULD OPEN AGAIN WITHIN THIRTY DAYS, CONTACT A QUALIFIED SERVICER TO CORRECT THE PROBLEM. IF YOU REPEATEDLY RESET THE BREAKER OR REPLACE THE FUSE WITHOUT HAVING THE PROBLEM CORRECTED, YOU RUN THE RISK OF SEVERE EQUIPMENT DAMAGE.

START-UP CHECKLIST

Condenser / Heat Pump (including all Inverter)			
	Model Number	_____	
	Serial Number	_____	
ELECTRICAL (Outdoor Unit)			
Line Voltage (Measure L1 and L2 Voltage)	L1 - L2	_____	
Secondary Voltage (Measure Transformer Output Voltage) NOT ALL MODELS	R - C	_____	
Compressor Amps		_____	
Condenser Fan Amps		_____	
TEMPERATURES (Indoor Unit)			
Return Air Temperature (Dry bulb / Wet bulb)		_____ DB °F	_____ WB °F
Cooling Supply Air Temperature (Dry bulb / Wet bulb)		_____ DB °F	_____ WB °F
Delta T (Difference between Supply and Return Temperatures)		_____ DB °F	
PRESSURES / TEMPERATURES (Outdoor Unit)			
Suction Circuit (Pressure / Suction Line Temperature)	PSIG	_____	TEMP _____ °F
Liquid Circuit (Pressure / Liquid Temperature)	PSIG	_____	TEMP _____ °F
Outdoor Air Temperature (Dry bulb / Wet bulb)		_____ DB °F	_____ WB °F
SUPERHEAT / SUBCOOLING			
Line set length in Feet	SH	_____	SC _____
Additional Refrigerant Charge Added over Factory Charge (Ounces)		_____	_____
Additional Checks			
Check wire routings for any rubbing		_____	
Check factory wiring and wire connections.		_____	
Check product for proper clearances as noted by installation instructions		_____	

°F to °C formula: (°F - 32) divided by 1.8 = °C °C to °F formula: (°C multiplied by 1.8) + 32 = °F			

CUSTOMER FEEDBACK

We are very interested in all product comments. Please fill out the feedback form on one of the following links:
Goodman® Brand Products: (<http://www.goodmanmfg.com/about/contact-us>).
Amana® Brand Products: (<http://www.amana-hac.com/about-us/contact-us>).
You can also scan the QR code on the right for the product brand you purchased to be directed to the feedback page.



GOODMAN® BRAND



AMANA® BRAND

PRODUCT REGISTRATION

Thank you for your recent purchase. Though not required to get the protection of the standard warranty, registering your product is a relatively short process, and entitles you to additional warranty protection, except that failure by California and Quebec residents to register their product does not diminish their warranty rights. The duration of warranty coverages in Texas differs in some cases.

For Product Registration, please register as follows:
Goodman® Brand products: (<https://www.goodmanmfg.com/product-registration>).
Amana® Brand products: (<http://www.amana-hac.com/product-registration>).
You can also scan the QR code on the right for the product brand you purchased to be directed to the Product Registration page.



GOODMAN® BRAND



AMANA® BRAND

NOTE: SPECIFICATIONS AND PERFORMANCE DATA LISTED HEREIN ARE SUBJECT TO CHANGE WITHOUT NOTICE.

Visit our website at www.goodmanmfg.com or www.amana-hac.com for information on:

- Products
- Warranties
- Customer Services
- Parts
- Contractor Programs and Training
- Financing Options

19001 Kermier Rd. Waller, TX 77484
www.goodmanmfg.com • www.amana-hac.com

© 2022 **DAIKIN COMFORT TECHNOLOGIES MANUFACTURING, L.P.**

Amana is a registered trademark of Maytag Corporation or its related companies and is used under license. All rights reserved.