

Service and Troubleshooting

A/GPU 13.4 SEER2 GAS-ELECTRIC ULTRA-LOW NOX HEATING & COOLING UNIT

Pride and workmanship go into every product to provide our customers with quality products. It is possible, however, that during its lifetime a product may require service. Products should be serviced only by a qualified service technician who is familiar with the safety procedures required in the repair and who is equipped with the proper tools, parts, testing instruments and the appropriate service manual. **REVIEW ALL SERVICE INFORMATION IN THE APPROPRIATE SERVICE MANUAL BEFORE BEGINNING REPAIRS.**

TABLE OF CONTENTS

IMPORTANT INFORMATION	2
PRODUCT IDENTIFICATION	4
SYSTEM OPERATION	6
SCHEDULED MAINTENANCE	10
SERVICING	13
CHECKING VOLTAGE	13
CHECKING WIRING	13
CHECKING THERMOSTAT AND WIRING	13
CHECKING TRANSFORMER AND CONTROL CIRCUIT	14
CHECKING CONTACTOR AND/OR RELAYS	14
CHECKING CONTACTOR CONTACTS	14
CHECKING FAN RELAY CONTACTS	15
CHECKING HIGH PRESSURE CONTROL	15
CHECKING LOW PRESSURE CONTROL	15
CHECKING CAPACITOR	15
CAPACITANCE CHECK (MFD)	16
CHECKING FAN AND BLOWER MOTOR WINDINGS(PSC MOTORS)	17
CHECKING ECM MOTOR WINDINGS	17
CHECKING EEM MOTORS	17
CHECKING COMPRESSOR	18
RESISTANCE TEST	18
GROUND TEST	19
UNLOADER TEST PROCEDURE	19
OPERATION TEST	20
LOCKED ROTOR TEST	20
TESTING CRANKCASE HEATER (OPTIONAL ITEM)	20
REFRIGERATION REPAIR PRACTICE	21
STANDING PRESSURE TEST	21
LEAK TESTING (NITROGEN OR NITROGEN-TRACED)	21
SYSTEM EVACUATION	22
DEEP VACUUM METHOD (RECOMMENDED)	22
TRIPLE EVACUATION METHOD (ALTERNATE)	22



WARNING

ONLY PERSONNEL THAT HAVE BEEN TRAINED TO INSTALL, ADJUST, SERVICE, MAINTENANCE OR REPAIR (HEREINAFTER, "SERVICE") THE EQUIPMENT SPECIFIED IN THIS MANUAL SHOULD SERVICE THE EQUIPMENT. THE MANUFACTURER WILL NOT BE RESPONSIBLE FOR ANY INJURY OR PROPERTY DAMAGE ARISING FROM IMPROPER SERVICE OR SERVICE PROCEDURES. IF YOU SERVICE THIS UNIT, YOU ASSUME RESPONSIBILITY FOR ANY INJURY OR PROPERTY DAMAGE WHICH MAY RESULT. IN ADDITION, IN JURISDICTIONS THAT REQUIRE ONE OR MORE LICENSES TO SERVICE THE EQUIPMENT SPECIFIED IN THIS MANUAL, ONLY LICENSED PERSONNEL SHOULD SERVICE THE EQUIPMENT. IMPROPER INSTALLATION, ADJUSTMENT, SERVICING, MAINTENANCE OR REPAIR OF THE EQUIPMENT SPECIFIED IN THIS MANUAL, OR ATTEMPTING TO INSTALL, ADJUST, SERVICE OR REPAIR THE EQUIPMENT SPECIFIED IN THIS MANUAL WITHOUT PROPER TRAINING MAY RESULT IN PRODUCT DAMAGE, PROPERTY DAMAGE, PERSONAL INJURY OR DEATH.



WARNING

DO NOT BYPASS SAFETY DEVICES.



IMPORTANT INFORMATION

CHARGING	23
REFRIGERANT CHARGE CHECK	23
SUPERHEAT	23
CHECKING SUBCOOLING	24
CHECKING COMPRESSOR EFFICIENCY	24
THERMOSTATIC EXPANSION VALVE	24
OVERFEEDING	25
UNDERFEEDING	25
CHECKING EXPANSION VALVE OPERATION	25
FIXED ORIFICE RESTRICTOR DEVICES	25
CHECKING RESTRICTED LIQUID LINE	27
OVERCHARGE OF REFRIGERANT	27
NON-CONDENSABLES	27
COMPRESSOR BURNOUT	27
SUCTION LINE DRIER CLEAN-UP METHOD	28
CHECKING EXTERNAL STATIC PRESSURE	28
CHECKING TEMPERATURE RISE	29
TESTING PRIMARY LIMIT CONTROL	29
TESTING AUXILIARY LIMIT	30
CHECKING BURNER TEMPERATURE SWITCH	30
LIMIT SWITCH OPERATION	31
TESTING INDUCER MOTOR	31
TESTING GAS VALVE	31
CHECKING GAS PRESSURE	32
CHECKING PRESSURE TRANSDUCER	32
FIELD TEST MODE	33
CHECKING INTEGRATED IGNITION CONTROL BOARD	33
CHECKING FOR DELAYED IGNITION	33
CHECKING FLAME SENSOR	34
DSI DIRECT SPARK IGNITION SYSTEMS	34
BLOWER PERFORMANCE DATA	35
TROUBLESHOOTING	37
WIRING DIAGRAMS	43

IMPORTANT NOTICES

RECOGNIZE SAFETY SYMBOLS, WORDS AND LABELS

	WARNING
<p>TO PREVENT THE RISK OF PROPERTY DAMAGE, PERSONAL INJURY, OR DEATH, DO NOT STORE COMBUSTIBLE MATERIALS OR USE GASOLINE OR OTHER FLAMMABLE LIQUIDS OR VAPORS IN THE VICINITY OF THIS APPLIANCE.</p>	

	WARNING
<p>HIGH VOLTAGE DISCONNECT ALL POWER BEFORE SERVICING OR INSTALLING THIS UNIT. MULTIPLE POWER SOURCES MAY BE PRESENT. FAILURE TO DO SO MAY CAUSE PROPERTY DAMAGE, PERSONAL INJURY OR DEATH.</p>	

	WARNING
<p>THIS UNIT SHOULD NOT BE CONNECTED TO, OR USED IN CONJUNCTION WITH, ANY DEVICES THAT ARE NOT DESIGN CERTIFIED FOR USE WITH THIS UNIT OR HAVE NOT BEEN TESTED AND APPROVED BY THE MANUFACTURER. SERIOUS PROPERTY DAMAGE OR PERSONAL INJURY, REDUCE UNIT PERFORMANCE AND/OR HAZARDOUS CONDITIONS MAY RESULT FROM THE USE OF DEVICES THAT HAVE NOT BEEN APPROVED OR CERTIFIED BY THE MANUFACTURER.</p>	

OUTSIDE THE U.S., call 1-713-861-2500.

(Not a technical assistance line for dealers.) Your telephone company will bill you for the call.

IMPORTANT INFORMATION

SAFE REFRIGERANT HANDLING

While these items will not cover every conceivable situation, they should serve as a useful guide.



WARNING

REFRIGERANTS ARE HEAVIER THAN AIR. THEY CAN "PUSH OUT" THE OXYGEN IN YOUR LUNGS OR IN ANY ENCLOSED SPACE. TO AVOID POSSIBLE DIFFICULTY IN BREATHING OR DEATH:

- NEVER PURGE REFRIGERANT INTO AN ENCLOSED ROOM OR SPACE. BY LAW, ALL REFRIGERANT MUST BE RECLAIMED.
- IF AN INDOOR LEAK IS SUSPECTED, THOROUGHLY VENTILATE THE AREA BEFORE BEGINNING WORK.
- LIQUID REFRIGERANT CAN BE VERY COLD. TO AVOID POSSIBLE FROSTBITE OR BLINDNESS, AVOID CONTACT WITH REFRIGERANT AND WEAR GLOVES AND GOGGLES. IF LIQUID REFRIGERANT DOES CONTACT YOUR SKIN OR EYES, SEEK MEDICAL HELP IMMEDIATELY.
- ALWAYS FOLLOW EPA REGULATIONS. NEVER BURN REFRIGERANT, AS POISONOUS GAS WILL BE PRODUCED.



WARNING

TO AVOID POSSIBLE INJURY, EXPLOSION OR DEATH, PRACTICE SAFE HANDLING OF REFRIGERANTS.



WARNING

THE COMPRESSOR POE OIL FOR R-410A UNITS IS EXTREMELY SUSCEPTIBLE TO MOISTURE ABSORPTION AND COULD CAUSE COMPRESSOR FAILURE. DO NOT LEAVE SYSTEM OPEN TO ATMOSPHERE ANY LONGER THAN NECESSARY FOR INSTALLATION.



WARNING

TO AVOID POSSIBLE EXPLOSION:

- NEVER APPLY FLAME OR STEAM TO A REFRIGERANT CYLINDER. IF YOU MUST HEAT A CYLINDER FOR FASTER CHARGING, PARTIALLY IMMERSE IT IN WARM WATER.
- NEVER FILL A CYLINDER MORE THAN 80% FULL OF LIQUID REFRIGERANT.
- NEVER ADD ANYTHING OTHER THAN R-22 TO AN R-22 CYLINDER OR R-410A TO AN R-410A CYLINDER. THE SERVICE EQUIPMENT USED MUST BE LISTED OR CERTIFIED FOR THE TYPE OF REFRIGERANT USED.
- STORE CYLINDERS IN A COOL, DRY PLACE. NEVER USE A CYLINDER AS A PLATFORM OR A ROLLER.



WARNING

TO AVOID POSSIBLE EXPLOSION, USE ONLY RETURNABLE (NOT DISPOSABLE) SERVICE CYLINDERS WHEN REMOVING REFRIGERANT FROM A SYSTEM.

- ENSURE THE CYLINDER IS FREE OF DAMAGE WHICH COULD LEAD TO A LEAK OR EXPLOSION.
- ENSURE THE HYDROSTATIC TEST DATE DOES NOT EXCEED 5 YEARS.
- ENSURE THE PRESSURE RATING MEETS OR EXCEEDS 400 LBS.

WHEN IN DOUBT, DO NOT USE CYLINDER.

PRODUCT IDENTIFICATION

NOMENCLATURE

The model number is used for positive identification of component parts used in manufacturing. Please use this number when requesting service or parts information.

	*	P	U	14	36	080	M	4	1	**		
	1	2	3	4,5	6,7	8,9,10	11	12	13	14,15		
Brand	G Goodman® brand		A Amana® brand									Engineering
												Major/ Minor Revisions
Product Category	P Packaged Unit									Electrical		
										1 208-230/1/60		
Unit Type	G Gas/Electric		D Dual-Fuel		U Ultra-Low NOx						Refrigerant	
											4 R-410A	
Efficiency	14 14 SEER									Airflow		
										M Multi-Position		
Nominal Capacity	24 2 Tons		36 3 Tons		48 4 Tons						Heat Input	
											40 40 MBTU/h	
	30 2½ tons		42 3 ½ Tons		60 5 Tons						60 60 MBTU/h	
											80 80 MBTU/h	

PRODUCT IDENTIFICATION

Single Phase Package Gas Units	
Model #	Description
APUM3[24-61]***M41AA	Amana ® Brand Ultra-Low NOx Package Gas 13.4 SEER(2) R410A Multi-Position gas / electric units. Initial release of models meeting DOE 2023 Regulatory Requirements.
GPUM3[24-61]***M41AA	Goodman ® Brand Ultra-Low NOx Package Gas 13.4 SEER(2) R410A Multi-Position gas / electric units. Initial release of models meeting DOE 2023 Regulatory Requirements.

These units have R410A refrigerant

SYSTEM OPERATION

COOLING

The refrigerant used in the system is R-410A. It is a clear, colorless, non-toxic and non-irritating liquid. R-410A is a 50:50 blend of R-32 and R-125. The boiling point at atmospheric pressure is -62.9°F.

A few of the important principles that make the refrigeration cycle possible are: heat always flows from a warmer to a cooler body. Under lower pressure, a refrigerant will absorb heat and vaporize at a low temperature. The vapors may be drawn off and condensed at a higher pressure and temperature to be used again.

The indoor evaporator coil functions to cool and dehumidify the air conditioned spaces through the evaporative process taking place within the coil tubes.

NOTE: The pressures and temperatures shown in the refrigerant cycle illustrations on the following pages are for demonstration purposes only. Actual temperatures and pressures are to be obtained from the "Expanded Performance Chart".

Liquid refrigerant at condensing pressure and temperatures, (270 psig and 122°F), leaves the outdoor condensing coil through the drier and is metered into the indoor coil through the metering device. As the cool, low pressure, saturated refrigerant enters the tubes of the indoor coil, a portion of the liquid immediately vaporizes. It continues to soak up heat and vaporizes as it proceeds through the coil, cooling the indoor coil down to about 48°F.

Heat is continually being transferred to the cool fins and tubes of the indoor evaporator coil by the warm system air. This warming process causes the refrigerant to boil. The heat removed from the air is carried off by the vapor.

As the vapor passes through the last tubes of the coil, it becomes superheated. That is, it absorbs more heat than is necessary to vaporize it. This is assurance that only dry gas will reach the compressor. Liquid reaching the compressor can weaken or break compressor valves.

The compressor increases the pressure of the gas, thus adding more heat, and discharges hot, high pressure super-heated gas into the outdoor condenser coil.

In the condenser coil, the hot refrigerant gas, being warmer than the outdoor air, first loses its superheat by heat transferred from the gas through the tubes and fins of the coil. The refrigerant now becomes saturated, part liquid, part vapor and then continues to give up heat until it condenses to a liquid alone. Once the vapor is fully liquefied, it continues to give up heat which subcools the liquid, and it is ready to repeat the cycle.

HEATING

The heating cycle is accomplished by using a unique tubular design heat exchanger which provides efficient gas heating on natural gas fuel. The heat exchanger's compact tubular construction provides excellent heat transfer for maximum operating efficiency.

The induced draft blower draws fuel and combustion air into the burner and through the heat exchanger for proper combustion.

Blower operation is controlled by the integrated control module. The module allows for field adjustment of the blower delay at the end of the heating cycle. The range of adjustment is 90, 120, 150 or 180 seconds. The factory delay settings are 30 seconds delay on, 150 seconds delay off.

DIRECT SPARK IGNITION (DSI) SYSTEMS

*PUM3 units are equipped with a direct spark ignition system. Ignition is provided by a 25,000 volt electronic spark. A flame sensor then monitors for the presence of flame and closes the gas valve if flame is lost.

PCBBL216 IGNITION CONTROL SEQUENCE OF OPERATION

CONTINUOUS FAN

1. When the thermostat calls for continuous fan (G) with out a call for heat or cooling, the indoor the fan has a 7 second delay on make and energizes the "HEAT" speed. The fan remains energized as long as the call for fan remains without a call for heat or cooling. The fan call "G" has a 60 second delay on break. **NOTE:** When the Configuration tab is broken, the continuous fan mode "G" will have a 7 second delay on make and a 60 second delay on break and the "COOL" speed tap will be energized.
2. If a call for cool (Y) occurs during continuous fan, the blower will switch over to "COOL" speed.
3. If a call for heat (W) occurs during continuous fan, the blower will remain energized through the heat cycle or until "G" is de-energized.
4. The continuous fan operation will function while the control is in heat mode lockout.

SYSTEM OPERATION

COOL MODE

1. When the thermostat calls for cooling (“Y”), the control energizes the cooling speed fan after a 7 second on delay. The control provides a 3 minute anti-short cycle protection for the compressor. If the compressor has been off for 3 or more minutes, the compressor immediately energizes when the thermostat calls for cool. If the compressor has not been off for at least 3 minutes when a call for cool occurs, the control waits until 3 minutes has elapsed from the time the compressor was last de-energized before re-energizing the compressor.
2. When the thermostat removes the call for cooling (“Y”) the compressor is deenergized and the control de-energizes the cooling speed fan after a cooling off delay period of 60 seconds.

NOTE: A call for cooling has priority over continuous fan. If G is energized while Y is energized, during the cooling fan on delay, the fan will remain off until the delay is over.

NOTE: The cooling fan operation will continue to function while the control is in heat lockout.

NOTE: If a call for heat exist with a call for cooling, the call for heat shall proceed as normal except the fan remains energized on cool speed.

HEAT MODE

The normal operational sequence in heating mode is as follows:

- R and W thermostat contacts close, initiating a call for heat.
- Integrated control module performs safety circuit checks.
- Pressure Sensor Verification: The control operates the inducer in a manner to verify the pressure sensor null value and span operation are within specification. If the system is operating correctly, this test takes only a few seconds. If the system is not functioning properly, the control times out after a maximum 90 seconds and displays the proper fault code.
- Induced draft blower is energized for 30 second prepurge.
- The control energizes the gas valve and spark igniter. If flame is not established within 4 seconds, the gas valve and spark igniter is de-energized and the control goes to an inter-purge. If the flame is established, the spark igniter is de-energized and the control goes to heat blower on delay.
- Heat Blower On Delay – The control waits for 30 second heat fan on delay and then energizes the indoor blower heat speed. If the blower is already energized by a continuous fan call, the on delay is skipped and control goes to heat fan speed.

- STEADY HEAT – Control inputs are continuously monitored for ensure limit and pressure switches are closed, flame is established and the thermostat call for heat remains.
- POST PURGE – When the thermostat demand for heat is satisfied, the control immediately de-energizes the gas valve. The inducer output remains on for a 30 second post-purge period.
- Heat Blower Off Delay – The indoor blower motor is de-energized after the selected blower off delay time. Blower timing begins when the thermostat is satisfied.

PCBBL216 ULN CONTROL ERROR CODES			
LED ACTIVITY	DESCRIPTION	COLOR	MINIMUM LOCKOUT PERIOD
LED OFF	NO 24 VAC POWER TO CONTROL	N/A	N/A
RED, AMBER, GREEN	POWER-UP VERIFICATION OF LED	N/A	N/A
STEADY ON	CONTROL FAULT DETECTED	RED	1 HOUR OR HARD LOCKOUT
1 FLASH	RETRIES EXCEEDED	RED	1 HOUR FIXED
2 FLASHES	PRESSURE SENSOR NULL ERROR	RED	5 MINUTES
3 FLASHES	PRESSURE SENSOR SPAN ERROR	RED	5 MINUTES
4 FLASHES	HIGH LIMIT SWITCH OPEN	RED	MAXIMUM RECOVERY TIME 1 HOUR AFTER MAX TRIPS EXCEEDED
5 FLASHES	FLAME PRESENT WITH GAS VALVE OFF	RED	5 MINUTES
6 FLASHES	NORMALLY CLOSED BLOCKED BURNER SWITCH / AUXILIARY SWITCH OPEN	RED	MAXIMUM RECOVERY TIME 1 HOUR IF TIME EXCEEDED
7 FLASHES	GAS VALVE CIRCUIT SHORTED	RED	1 HOUR
8 FLASHES	RESERVED	RED	N/A
10 FLASHES	HIGH LIMIT SWITCH RECOVERY TIMER EXPIRED	RED	1 HOUR OR HARD LOCKOUT
STEADY ON	OEM FACTORY TEST MODE	AMBER	N/A
RAPID FLASH	FIELD TEST MODE	AMBER	N/A
1 FLASH	LOW FLAME SENSE	AMBER	N/A
2 FLASHES	ID PLUG FAILURE	AMBER	HARD LOCKOUT HEATING MODE
3 FLASHES	CONTROL FUSE OPEN	AMBER	5 MINUTES
STEADY ON	STANDBY NORMAL OPERATION NO THERMOSTAT CALL	GREEN	N/A
RAPID FLASH	CLEAR ERROR HISTORY	GREEN	N/A
1 FLASH	CALL FOR HEATING	GREEN	N/A
2 FLASHES	CALL FOR COOLING	GREEN	N/A
3 FLASHES	CONTINUOUS FAN OPERATION	GREEN	N/A

PCBBL216 ULN CONTROL LED STATUS CODES

SYSTEM OPERATION

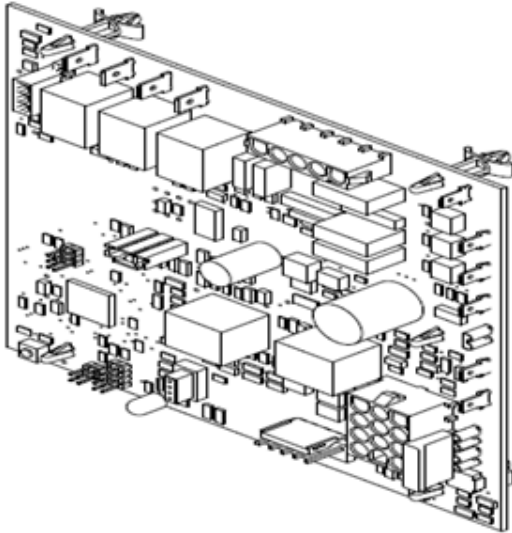

ID PLUGS FOR ULN GAS PACKAGE UNITS

Each 80% ULN model has a unique ID Plug that needs to be installed into the board for your specific model number. The ID Plug will populate the board with the correct operating parameters for each model and should be left on the board once installed.

Please see the table below for reference:

Part Number	Goodman / Amana
0130G00012	*PUM3**040M41AA
0130G00013	*PUM3**060M41AA
0130G00014	*PUM3**080M41AA

ID PLUG INSTALLATION

The following procedure will ensure the proper operating parameters are installed onto the board. Each model has a unique ID PLUG that needs to be installed onto the board.

Please see the instructions below:

1. Select the appropriate ID plug for the installed model number from the table above.
2. Attached the appropriate ID plug for the installed model number to the control board into the blue connector as shown below. This will load the correct parameters to the board. Failure to follow these instructions will result in the board not functioning.

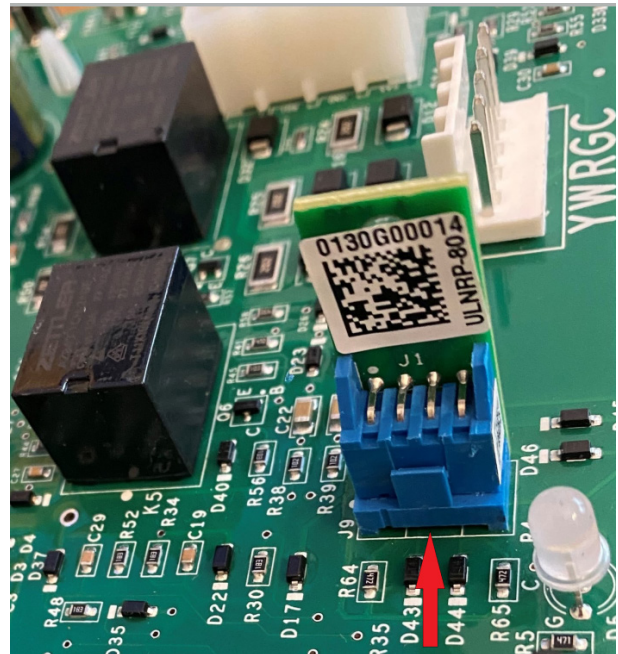

SYSTEM OPERATION

TYPICAL PACKAGE COOLING OR PACKAGE GAS

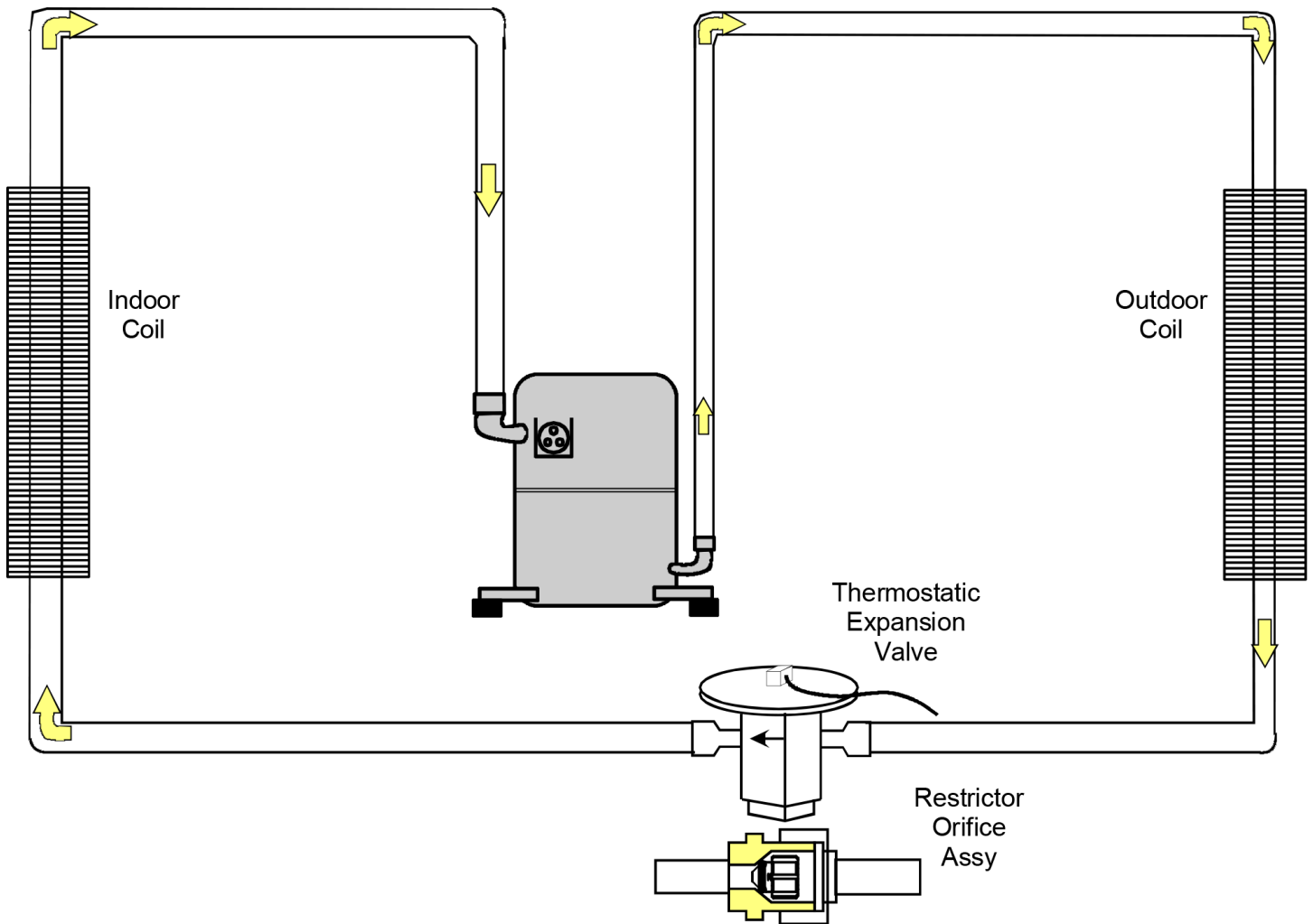

Either a thermostatic expansion valve or restrictor orifice assembly may be used depending on model, refer to the parts catalog for the model being serviced.

RESTRICTOR ORIFICE ASSEMBLY IN COOLING OPERATION

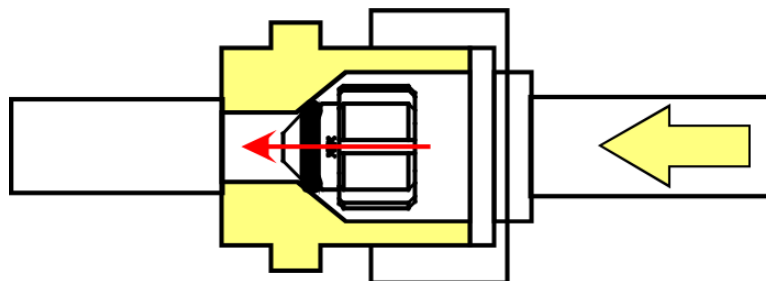



In the cooling mode, the orifice is pushed into its seat forcing refrigerant to flow through the metered hole in the center of the orifice.

SCHEDULED MAINTENANCE

Package gas units require regularly scheduled maintenance to preserve high performance standards, prolong the service life of the equipment, and lessen the chances of costly failure.

In many instances the owner may be able to perform some of the maintenance; however, the advantage of a service contract, which places all maintenance in the hands of a trained serviceman, should be pointed out to the owner.

 WARNING	
HIGH VOLTAGE DISCONNECT ALL POWER BEFORE SERVICING OR INSTALLING THIS UNIT. MULTIPLE POWER SERVICING OR INSTALLING THIS UNIT. MULTIPLE POWER SOURCES MAY BE PRESENT. FAILURE TO DO SO MAY CAUSE PROPERTY DAMAGE, PERSONAL INJURY OR DEATH.	

ONCE A MONTH

1. Inspect the return filters of the evaporator unit and clean or change if necessary.

NOTE: Depending on operation conditions, it may be necessary to clean or replace the filters more often. If permanent type filters are used, they should be washed with warm water and dried.

2. When operating on the cooling cycle, inspect the condensate line piping from the evaporator coil. Make sure the piping is clear for proper condensate flow.

ONCE A YEAR

QUALIFIED SERVICE PERSONNEL ONLY

1. Clean the indoor and outdoor coils.
2. Clean the cabinet inside and out.
3. Motors are permanently lubricated and do not require oiling. TO AVOID PREMATURE MOTOR FAILURE, DO NOT OIL.
4. Manually rotate the outdoor fan and indoor blower to be sure they run freely.
5. Inspect the control panel wiring, compressor connections, and all other component wiring to be sure all connections are tight. Inspect wire insulation to be certain that it is good.
6. Check the contacts of the compressor contactor. If they are burned or pitted, replace the contactor.
7. Using a halide or electronic leak detector, check all piping and etc. for refrigerant leaks.
8. Check the combustion chamber (Heat Exchanger) for soot, scale, etc. Inspect all burners for lint and proper positioning.

9. Start the system, using the proper instrumentation check gas inlet and manifold pressures, burner flame and microamp signal. Adjust if necessary.
10. Start the system and run a Heating Performance Test. If the results of the test are not satisfactory, see the Servicing sections for the possible cause.

TEST EQUIPMENT

Proper test equipment for accurate diagnosis is as essential as regular hand tools.

The following is a must for every service technician and service shop:

1. Thermocouple type temperature meter - Measure dry bulb temperature.
2. Sling psychrometer- Measure relative humidity and wet bulb temperature.
3. Volt-Ohm Meter - Testing continuity, capacitors, motor windings and voltage.
4. Accurate Leak Detector - Testing for refrigerant leaks.
5. High Vacuum Pump - Evacuation.
6. Electric Vacuum Gauge, Manifold Gauges and high vacuum hoses - To measure and obtain proper vacuum.
7. Accurate Charging Cylinder or Electronic Scale - Measure proper refrigerant charge.
8. Inclined Manometer - Measure static pressure and pressure drop across coils.

Other recording type instruments can be essential in solving abnormal problems, however, in many instances they may be rented from local sources.

Proper equipment promotes faster, more efficient service, and accurate repairs with less call backs.

HEATING PERFORMANCE TEST

Before attempting to diagnose an operating fault code, run a Heating Performance Test to determine if the heating system is performing within 5% of the BTU input found on the rating plate of the unit being tested. To conduct a heating performance test, the BTU input to the unit must be calculated (see Clocking a Gas Meter). Before clocking a gas meter, contact your local utility to provide the caloric value (BTU content) of the natural gas in the area.

It is also important to confirm the airflow (CFM) is within the temperature rise range (see Airflow Data in spec sheet) and external static pressure range (approximately 0.5" water column). How-to instructions can be found in the service manual under Checking External Static Pressure and Checking Temperature Rise.

SCHEDULED MAINTENANCE

CLOCKING A GAS METER

1. Turn off all gas appliances in the home.
2. Turn on the furnace. Ensure the furnace is operating at a 100% firing rate on 2 stage and modulating furnace product.
3. Once heating cycle is at a steady state (typically 15 minutes of operation), use a stopwatch to time how long it takes the smallest unit of measure dial on the gas meter to make a full revolution. In Table 1, one cubic foot is selected. The smallest unit of measure will vary depending on the gas meter.

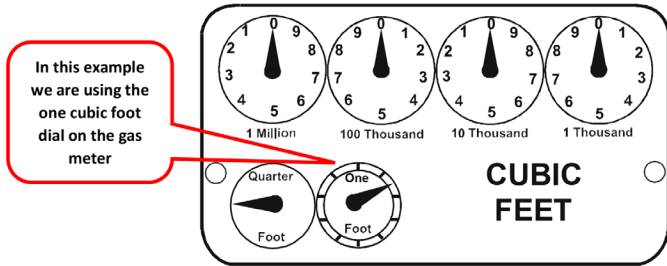

TABLE 1

4. Using Table 2 below, find the number of seconds it took for the dial to make a full revolution. To the right of that number of seconds and below the Size of Test Dial (selected in step 3 and shown in Table 1) will be the Cubic Feet per Hour (CFH).
5. Use this formula to verify the Cubic Feet per Hour (CFH) input determined in step 4 is correct:

$$(3600 \times \text{Gas Meter Dial Size}) / \text{Time (seconds)} = \text{Cubic Feet per Hour (CFH)}$$

3600 is used as there are 60 seconds in a minute and 60 minutes in an hour.
 $60 \times 60 = 3600$

6. Check with your local utility for actual BTU content (caloric value) of natural gas in the area (the average is 1025 BTU's).
7. Use this formula to calculate the BTU/HR input (See BTU/HR Calculation Example):
Cubic Feet per Hour (CFH) x BTU content of your natural gas = BTU/HR input
8. Should the figure you calculated not fall within five (5) percent of the nameplate rating of the unit, adjust the gas valve pressure regulator or resize orifices. To adjust the pressure regulator on the gas valve, turn downward (clockwise) to increase pressure and input, and upward (counterclockwise) to decrease pressure and input. A properly operating unit must have the BTU per hour input and CFM of air, within the limits shown to prevent short cycling of the equipment. As the external static pressure goes up, the temperature rise will also increase. Consult the proper tables for temperature rise limitation.

BTU/HR CALCULATION EXAMPLE:

The unit being tested takes 40 seconds for the 1 cubic foot dial to make one complete revolution. Using the chart, this translates to 90 cubic feet per hour. Based upon the assumption that one cubic foot of natural gas has 1,025 BTU's (Check with your local utility for actual BTU content), the calculated input is 92,250 BTU's per hour.

Furnace Nameplate Input in this example: 90,000 BTU/HR

Calculated Gas Input in this example: 92,250 BTU/HR
This example is within the 5% tolerance input and does not need adjustment.

SCHEDULED MAINTENANCE

Locate 40 seconds for one revolution in the chart below



Then locate the 1 cu ft dial column and select the corresponding CFH from the 40 seconds for one revolution row

GAS RATE -- CUBIC FEET PER HOUR											
Seconds for One Revolution	Size of Test Dial					Seconds for One Revolution	Size of Test Dial				
	1/4 cu/ft	1/2 cu/ft	1 cu/ft	2 cu/ft	5 cu/ft		1/4 cu/ft	1/2 cu/ft	1 cu/ft	2 cu/ft	5 cu/ft
10	90	180	360	720	1800	36	25	50	100	200	500
11	82	164	327	655	1636	37	--	--	97	195	486
12	75	150	300	600	1500	38	23	47	95	189	474
13	69	138	277	555	1385	39	--	--	92	185	462
14	64	129	257	514	1286	40	22	45	90	180	450
15	60	120	240	480	1200	41	--	--	--	176	439
16	56	113	225	450	1125	42	21	43	86	172	429
17	53	106	212	424	1059	43	--	--	--	167	419
18	50	100	200	400	1000	44	--	41	82	164	409
19	47	95	189	379	947	45	20	40	80	160	400
20	45	90	180	360	900	46	--	--	78	157	391
21	43	86	171	343	857	47	19	38	76	153	383
22	41	82	164	327	818	48	--	--	75	150	375
23	39	78	157	313	783	49	--	--	--	147	367
24	37	75	150	300	750	50	18	36	72	144	360
25	36	72	144	288	720	51	--	--	--	141	355
26	34	69	138	277	692	52	--	--	69	138	346
27	33	67	133	265	667	53	17	34	--	136	340
28	32	64	129	257	643	54	--	--	67	133	333
29	31	62	124	248	621	55	--	--	--	131	327
30	30	60	120	240	600	56	16	32	64	129	321
31	--	--	116	232	581	57	--	--	--	126	316
32	28	56	113	225	563	58	--	31	62	124	310
33	--	--	109	218	545	59	--	--	--	122	305
34	26	53	106	212	529	60	15	30	60	120	300
35	--	--	103	206	514						

TABLE 2

SERVICING

CHECKING VOLTAGE

 WARNING
<p>HIGH VOLTAGE! DISCONNECT ALL POWER BEFORE SERVICING OR INSTALLING. MULTIPLE POWER SOURCES MAY BE PRESENT. FAILURE TO DO SO MAY CAUSE PROPERTY DAMAGE, PERSONAL INJURY OR DEATH.</p> 

1. Remove doors, control panel cover, etc. from unit being tested.

With power ON:



 WARNING
<p>LINE VOLTAGE NOW PRESENT.</p>

2. Using a voltmeter, measure the voltage across terminals L1 and L2 of the contactor for single phase units.
3. No reading - indicates open wiring, open fuse(s) no power or etc. from unit to fused disconnect service. Repair as needed.
4. If incoming voltage is within the range listed in the chart below, energize the unit.
5. Using a voltmeter, measure the voltage with the unit starting and operating to determine if voltage is within the range listed in the chart below.
6. If the voltage falls below the minimum voltage, check the line wire size. Long runs of undersized wire can cause low voltage. If the wire size is adequate, notify the local power company regarding either low or high voltage.

UNIT VOLTAGE

Rated Voltage	Minimum Supply Voltage	Maximum Supply Voltage
208/230V	197	253

CHECKING WIRING

 WARNING
<p>HIGH VOLTAGE! DISCONNECT ALL POWER BEFORE SERVICING OR INSTALLING. MULTIPLE POWER SOURCES MAY BE PRESENT. FAILURE TO DO SO MAY CAUSE PROPERTY DAMAGE, PERSONAL INJURY OR DEATH.</p> 

1. Check wiring visually for signs of overheating, damaged insulation and loose connections.
2. Use an ohmmeter to check continuity of any suspected open wires.
3. If any wires must be replaced, replace with comparable gauge and insulation thickness.

CHECKING THERMOSTAT AND WIRING

Thermostat Wiring: The maximum wire length for 18 AWG thermostat wire is 100 feet.

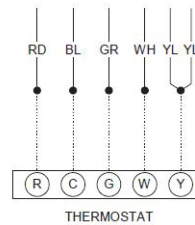

1 STAGE COOLING - 1 PHASE POWER

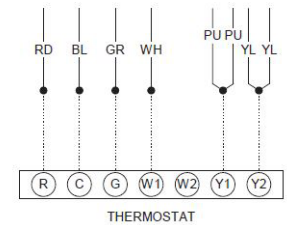

2 STAGE COOLING - 1 PHASE POWER



WIRING LEGEND

-  FACTORY WIRING
-  FIELD WIRING
-  WIRE NUT CONNECTION

 WARNING
<p>LINE VOLTAGE NOW PRESENT.</p>

With power ON, thermostat calling for cooling

1. Use a voltmeter to check for 24 volts at thermostat wires C and Y in the condensing unit control panel.
2. No voltage indicates trouble in the thermostat, wiring or external transformer source.
3. Check the continuity of the thermostat and wiring. Repair or replace as necessary.

INDOOR BLOWER MOTOR



With power ON:

 WARNING
<p>LINE VOLTAGE NOW PRESENT.</p>

1. Set fan selector switch at thermostat to "ON" position.
2. With voltmeter, check for 24 volts at wires C and G.
3. No voltage indicates the trouble is in the thermostat or wiring.
4. Check the continuity of the thermostat and wiring. Repair or replace as necessary.

SERVICING

CHECKING TRANSFORMER AND CONTROL CIRCUIT

 WARNING
<p>HIGH VOLTAGE! DISCONNECT ALL POWER BEFORE SERVICING OR INSTALLING. MULTIPLE POWER SOURCES MAY BE PRESENT. FAILURE TO DO SO MAY CAUSE PROPERTY DAMAGE, PERSONAL INJURY OR DEATH.</p> 

A step-down transformer (208/240 volt primary to 24 volt secondary) is provided with each indoor unit. This allows ample capacity for use with resistance heaters. The outdoor sections do not contain a transformer.

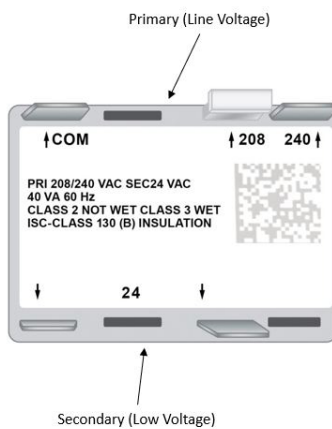

 WARNING
DISCONNECT ALL POWER BEFORE SERVICING.



1. Remove control panel cover, or etc., to gain access to transformer.

With power ON:

 WARNING
LINE VOLTAGE NOW PRESENT.

2. Using a voltmeter, check voltage across secondary voltage side of transformer (R to C).
3. No voltage indicates faulty transformer, bad wiring, or bad splices.
4. Check transformer primary voltage at incoming line voltage connections and/or splices.
5. If line voltage available at primary voltage side of transformer and wiring and splices good, transformer is inoperative. Replace.

CHECKING CONTACTOR AND/OR RELAYS

 WARNING
<p>HIGH VOLTAGE! DISCONNECT ALL POWER BEFORE SERVICING OR INSTALLING. MULTIPLE POWER SOURCES MAY BE PRESENT. FAILURE TO DO SO MAY CAUSE PROPERTY DAMAGE, PERSONAL INJURY OR DEATH.</p> 

The compressor contactor and other relay holding coils are wired into the low or line voltage circuits. When the control circuit is energized, the coil pulls in the normally open contacts or opens the normally closed contacts. When the coil is de-energized, springs return the contacts to their normal position.



NOTE: Most single phase contactors break only one side of the line (L1), leaving 115 volts to ground present at most internal components.

1. Remove the leads from the holding coil.
2. Using an ohmmeter, test across the coil terminals.

If the coil does not test continuous, replace the relay or contactor.

CHECKING CONTACTOR CONTACTS

SINGLE PHASE

 WARNING
<p>HIGH VOLTAGE! DISCONNECT ALL POWER BEFORE SERVICING OR INSTALLING. MULTIPLE POWER SOURCES MAY BE PRESENT. FAILURE TO DO SO MAY CAUSE PROPERTY DAMAGE, PERSONAL INJURY OR DEATH.</p> 

1. Disconnect the wire leads from the terminal (T) side of the contactor.
2. With power ON, energize the contactor.

 WARNING
LINE VOLTAGE NOW PRESENT.

SERVICING

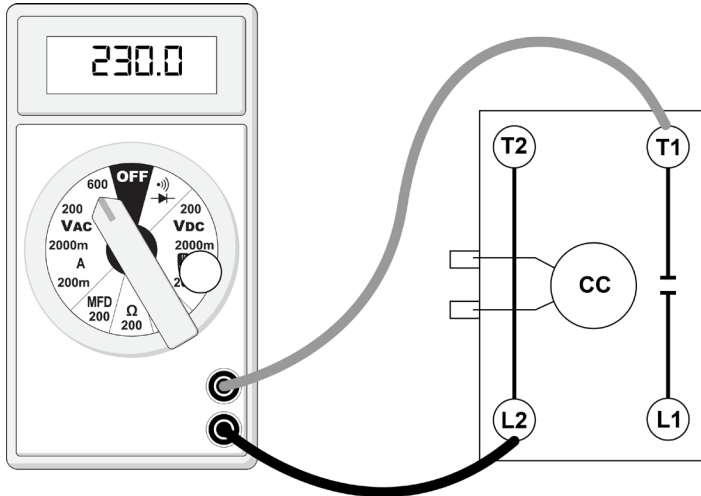

**TESTING COMPRESSOR CONTACTOR
(SINGLE PHASE)**

3. Using a voltmeter, test across terminals.
 - A. L1 - L2 - No voltage. Check breaker or fuses on main power supply.
 - B. L2 - T1 - No voltage indicates CC1 contacts open.

If a no voltage reading is obtained - replace the contactor.

CHECKING FAN RELAY CONTACTS

The fan relays are incorporated into the control board. See Testing Ignition Control Module for checking control board.

CHECKING HIGH PRESSURE CONTROL

WARNING
<p>HIGH VOLTAGE! DISCONNECT ALL POWER BEFORE SERVICING OR INSTALLING. MULTIPLE POWER SOURCES MAY BE PRESENT. FAILURE TO DO SO MAY CAUSE PROPERTY DAMAGE, PERSONAL INJURY OR DEATH.</p>

WARNING
<p>DO NOT BYPASS SAFETY DEVICES.</p>

The high pressure control senses the pressure in the liquid line. If abnormally high condensing pressures develop, the contacts of the control open, breaking the control circuit before the compressor motor overloads. This control is automatically reset.

1. Using an ohmmeter, check across terminals of high pressure control, with wire removed. If not continuous, the contacts are open.

2. Attach a gauge to the high pressure service port.

With power ON:

WARNING
<p>LINE VOLTAGE NOW PRESENT.</p>

3. Start the system and place a piece of cardboard in front of the condenser coil, raising the condensing pressure.
4. Check pressure at which the high pressure control cuts-out.

If it cuts-out at 660 PSIG \pm 10 PSIG, it is operating normally. If it cuts out below this pressure range, replace the control. The control should reset at 420 PSIG \pm 25 PSIG.

CHECKING LOW PRESSURE CONTROL

The low pressure control senses the pressure in the suction line and will open its contacts on a drop in pressure. The low pressure control will automatically reset itself with a rise in pressure.

The low pressure control is designed to cut-out (open) at approximately 55 PSIG \pm 7 PSIG. It will automatically cut-in (close) at approximately 95 PSIG \pm 7 PSIG.

Test for continuity using a VOM and if not as above, replace the control.

CHECKING CAPACITOR

CAPACITOR, RUN

A run capacitor is wired across the auxiliary and main windings of a single phase permanent split capacitor motor. The capacitors primary function is to reduce the line current while greatly improving the torque characteristics of a motor. This is accomplished by using the 90° phase relationship between the capacitor current and voltage in conjunction with the motor windings so that the motor will give two phase operation when connected to a single phase circuit. The capacitor also reduces the line current to the motor by improving the power factor.

CAPACITOR, START

SCROLL COMPRESSOR MODELS

Hard start components are not required on Scroll compressor equipped units due to a non-replaceable check valve located in the discharge line of the compressor. However hard start kits are available and may improve low voltage starting characteristics.

SERVICING

This check valve closes off high side pressure to the compressor after shut down allowing equalization through the scroll flanks. Equalization requires only about one or two seconds during which time the compressor may turn backwards.

Your unit comes with a 180-second anti-short cycle to prevent the compressor from starting and running backwards.

MODELS EQUIPPED WITH A HARD START DEVICE

A start capacitor is wired in parallel with the run capacitor to increase the starting torque. The start capacitor is of the electrolytic type, rather than metallized polypropylene as used in the run capacitor.

A switching device must be wired in series with the capacitor to remove it from the electrical circuit after the compressor starts to run. Not removing the start capacitor will overheat the capacitor and burn out the compressor windings.

These capacitors have a 15,000 ohm, 2 watt resistor wired across its terminals. The object of the resistor is to discharge the capacitor under certain operating conditions, rather than having it discharge across the closing of the contacts within the switching device such as the Start Relay, and to reduce the chance of shock to the servicer. See the Servicing Section for specific information concerning capacitors.

RELAY, START

A potential or voltage type relay is used to take the start capacitor out of the circuit once the motor comes up to speed. This type of relay is position sensitive. The normally closed contacts are wired in series with the start capacitor and the relay holding coil is wired parallel with the start winding. As the motor starts and comes up to speed, the increase in voltage across the start winding will energize the start relay holding coil and open the contacts to the start capacitor.

TESTING START RELAY KITS

TESTING COIL RELAY

1. Disconnect power to unit.
2. Disconnect all wiring.
3. Measure the resistance of the coil between terminals 2 & 5.
4. If the coil reads open or shorted, replace the relay.

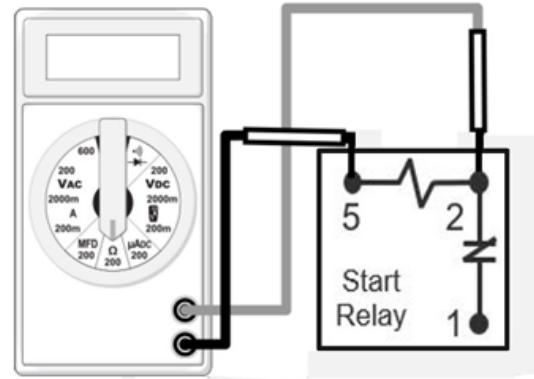

TESTING RELAY CONTACTS

TESTING CONTACTS RESISTANCE

- A. Disconnect power to unit.
- B. Disconnect all wiring to the start relay.
- C. Measure the resistance of the contacts between terminals 1 & 2.
- D. If the contacts read open, replace the relay.

TESTING CONTACTS VOLTAGE

- A. With power on, provide a call for cool to energize the compressor.
- B. With the compressor running, use a voltmeter to measure the voltage between terminals 1 & 2.
- C. Voltage reading of zero indicates that the relay's contacts are stuck, replace the relay.

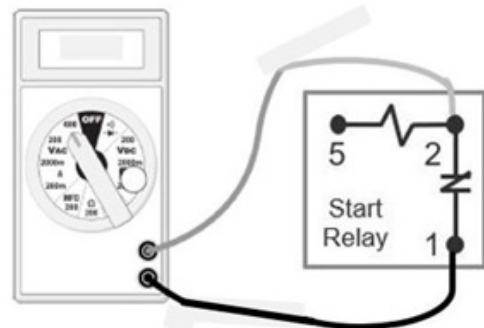

TESTING RELAY CONTACTS

CAPACITANCE CHECK (MFD)



WARNING

DISCHARGE CAPACITOR THROUGH A 20 TO 30 OHM RESISTOR BEFORE HANDLING.

1. Turn power off to unit.
2. Discharge capacitor through a 20Ω - 30Ω resistor.
3. Remove wires from capacitor.
4. Use multi-meter check micro-farads (MFD) of the capacitor.
5. Place leads from C – HERM.

SERVICING

- Place leads from C – FAN.
- Compare to capacitor rating label. If the reading is within the tolerance listed on rating label the capacitor is good.

If the reading is lower, the capacitor is bad and must be replaced.

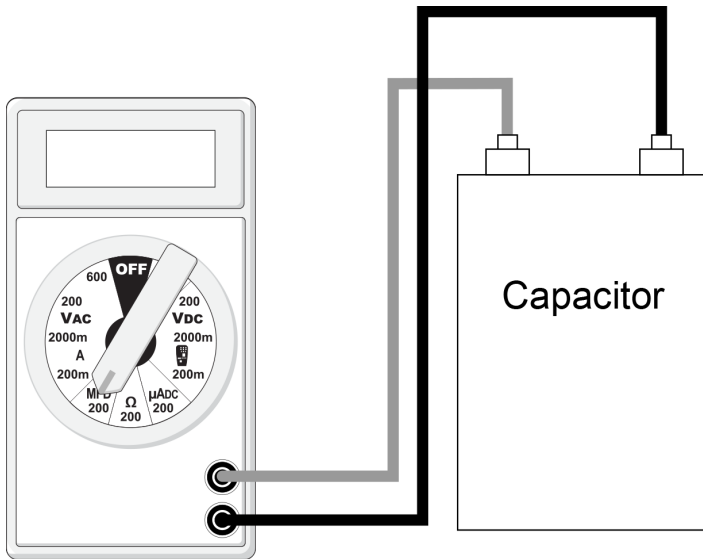

TESTING CAPACITANCE

CHECKING FAN AND BLOWER MOTOR WINDINGS (PSC MOTORS)

The auto reset fan motor overload is designed to protect the motor against high temperature and high amperage conditions by breaking the common circuit within the motor, similar to the compressor internal overload. However, heat generated within the motor is faster to dissipate than the compressor, allow at least 45 minutes for the overload to reset, then retest.

WARNING

HIGH VOLTAGE!
DISCONNECT ALL POWER BEFORE SERVICING OR INSTALLING. MULTIPLE POWER SOURCES MAY BE PRESENT. FAILURE TO DO SO MAY CAUSE PROPERTY DAMAGE, PERSONAL INJURY OR DEATH.

- Remove the motor leads from its respective connection points and capacitor (if applicable).
- Check the continuity between each of the motor leads.
- Touch one probe of the ohmmeter to the motor frame (ground) and the other probe in turn to each lead.

If the windings do not test continuous or a reading is obtained from lead to ground, replace the motor.

CHECKING ECM MOTOR WINDINGS

WARNING

HIGH VOLTAGE!
DISCONNECT ALL POWER BEFORE SERVICING OR INSTALLING. MULTIPLE POWER SOURCES MAY BE PRESENT. FAILURE TO DO SO MAY CAUSE PROPERTY DAMAGE, PERSONAL INJURY OR DEATH.

- Disconnect the 5-pin and the 16-pin connectors from the ECM power head.
- Remove the 2 screws securing the ECM power head and separate it from the motor.
- Disconnect the 3-pin motor connector from the power head and lay it aside.
- Using an ohmmeter, check the motor windings for continuity to ground (pins to motor shell). If the ohmmeter indicates continuity to ground, the motor is defective and must be replaced.
- Using an ohmmeter, check the windings for continuity (pin to pin). If no continuity is indicated, the thermal limit (over load) device may be open. Allow motor to cool and retest.

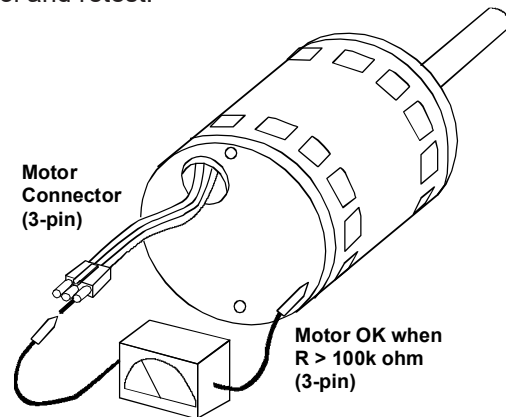

WINDING TEST

CHECKING EEM MOTORS

The EEM motor is a one piece, fully encapsulated, 3 phase brushless DC (single phase AC input) motor with ball bearing construction. The EEM motor features an integral control module.

NOTE: The GE TECMate will not currently operate the EEM motor.

- Using a voltmeter, check for 230 volts to the motor connections L and N. If 230 volts is present, proceed to step 2. If 230 volts is not present, check the line voltage circuit to the motor.
- Using a voltmeter, check for 24 volts from terminal C to either terminal 1, 2, 3, 4, or 5, depending on which tap is being used, at the motor. If voltage present, proceed to step 3. If no voltage, check 24 volt circuit to motor.

SERVICING

- If voltage was present in steps 1 and 2, the motor has failed and will need to be replaced.

NOTE: When replacing motor, ensure the belly band is between the vents on the motor and the wiring has the proper drip loop to prevent condensate from entering the motor.

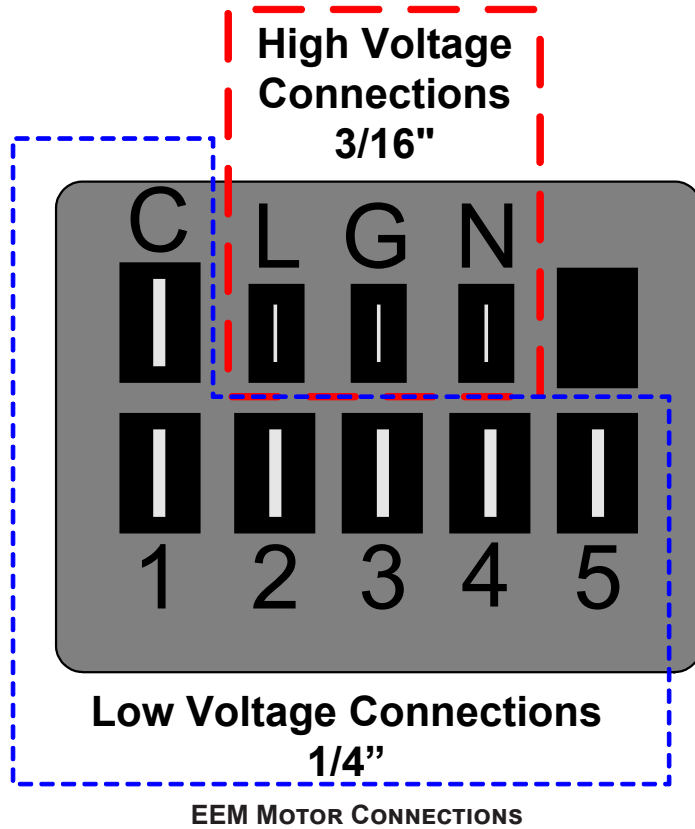

CHECKING COMPRESSOR

 WARNING
<p>HERMETIC COMPRESSOR ELECTRICAL TERMINAL VENTING CAN BE DANGEROUS. WHEN INSULATING MATERIAL WHICH SUPPORTS A HERMETIC COMPRESSOR OR ELECTRICAL TERMINAL SUDDENLY DISINTEGRATES DUE TO PHYSICAL ABUSE OR AS A RESULT OF AN ELECTRICAL SHORT BETWEEN THE TERMINAL AND THE COMPRESSOR HOUSING, THE TERMINAL MAY BE EXPELLED, VENTING THE VAPOR AND LIQUID CONTENTS OF THE COMPRESSOR HOUSING AND SYSTEM.</p>

If the compressor terminal PROTECTIVE COVER and gasket (if required) are not properly in place and secured, there is a remote possibility if a terminal vents, that the vaporous and liquid discharge can be ignited, spouting flames several feet, causing potentially severe or fatal injury to anyone in its path.

This discharge can be ignited external to the compressor if the terminal cover is not properly in place and if the discharge impinges on a sufficient heat source.

Ignition of the discharge can also occur at the venting terminal or inside the compressor, if there is sufficient contaminant air present in the system and an electrical arc occurs as the terminal vents.

Ignition cannot occur at the venting terminal without the presence of contaminant air, and cannot occur externally from the venting terminal without the presence of an external ignition source.

Therefore, proper evacuation of a hermetic system is essential at the time of manufacture and during servicing. To reduce the possibility of external ignition, all open flame, electrical power, and other heat sources should be extinguished or turned off prior to servicing a system.



RESISTANCE TEST

Each compressor is equipped with an internal overload.

The line break internal overload senses both motor amperage and winding temperature. High motor temperature or amperage heats the disc causing it to open, breaking the common circuit within the compressor on single phase units.

Heat generated within the compressor shell, usually due to recycling of the motor, high amperage or insufficient gas to cool the motor, is slow to dissipate. Allow at least three to four hours for it to cool and reset, then retest.

Fuse, circuit breaker, ground fault protective device, etc. has not tripped -

 WARNING	
<p>HIGH VOLTAGE! DISCONNECT ALL POWER BEFORE SERVICING OR INSTALLING. MULTIPLE POWER SOURCES MAY BE PRESENT. FAILURE TO DO SO MAY CAUSE PROPERTY DAMAGE, PERSONAL INJURY OR DEATH.</p>	

- Remove the leads from the compressor terminals.

 WARNING
<p>SEE WARNINGS BEFORE REMOVING COMPRESSOR TERMINAL COVER.</p>

- Using an ohmmeter, test continuity between terminals S-R, C-R, and C-S.

SERVICING

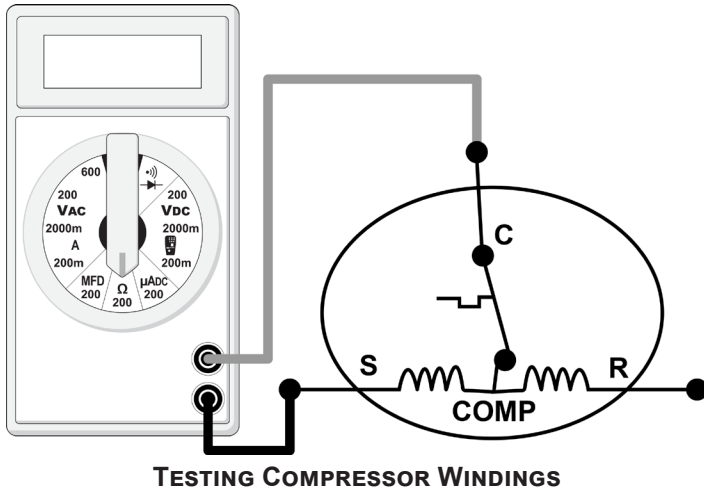

If either winding does not test continuous, replace the compressor.

NOTE: If an open compressor is indicated, allow ample time for the internal overload to reset before replacing compressor.

GROUND TEST

If fuse, circuit breaker, ground fault protective device, etc. has tripped, this is a strong indication that an electrical problem exists and must be found and corrected. The circuit protective device rating must be checked and its maximum rating should coincide with that marked on the equipment nameplate.

With the terminal protective cover in place, it is acceptable to replace the fuse or reset the circuit breaker **ONE TIME ONLY** to see if it was just a nuisance opening. If it opens again, **DO NOT** continue to reset.

Disconnect all power to unit, making sure that all power legs are open.

1. Carefully remove the compressor terminal protective cover and inspect for loose leads or insulation breaks in the lead wires.
2. Disconnect the three leads going to the compressor terminals at the compressor or nearest point to the compressor.
3. Check for a ground separately between each of the three terminals and ground (such as an unpainted tube on the compressor). If there is any reading of continuity to ground on the meter, the compressor should be considered defective.
4. If ground is indicated, replace the compressor.

⚠ WARNING

DAMAGE CAN OCCUR TO THE GLASS EMBEDDED TERMINALS IF THE LEADS ARE NOT PROPERLY REMOVED. THIS CAN RESULT IN TERMINAL AND HOT OIL DISCHARGING.

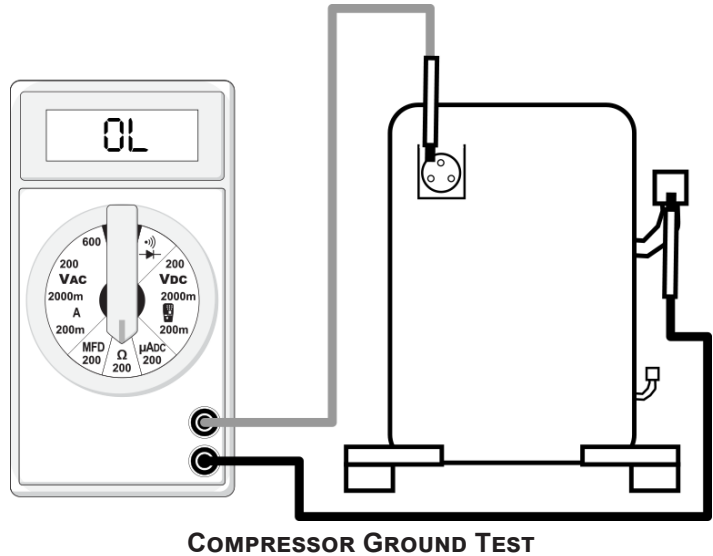

UNLOADER TEST PROCEDURE (2 STAGE COMPRESSORS ONLY)

A nominal 24-volt direct current coil activates the compressor internal unloader solenoid. The input control circuit voltage must be 18 to 28 volt AC. The coil power requirement is 5 VA. The external electrical connection is made with a molded plug assembly. This plug contains a full wave rectifier to supply direct current to the unloader coil. The measured DC voltage at the connectors in the plug should be 15 to 27 volt DC.

UNLOADER TEST PROCEDURE

If it is suspected that the unloader is not working, the following methods may be used to verify operation.



1. Operate the system and measure compressor amperage. Cycle the unloader ON and OFF at 10 second intervals. The compressor amperage should increase when switching from part-load to full-load and decrease when switching from full-load to part-load. The percent change depends on the operating conditions and voltage, but should be at least 25 percent.
2. If step one does not give the expected results, shut unit off. Apply 18 to 28 volt AC to the unloader molded plug leads and listen for a click as the solenoid pulls in. Remove power and listen for another click as the unloader returns to its original position.

SERVICING

3. If clicks can't be heard, shut off power to the unit and remove the control circuit molded plug from the compressor and measure the unloader coil resistance (connections on the compressor). The solenoid coil should have continuity and not be grounded or have infinite resistance. If the coil resistance is infinite, zero, or grounded, the compressor must be replaced.
4. Next check the molded plug.
 - A. Voltage check: Apply control voltage to the plug wires (18 to 28 volt ac). The measured dc voltage at the female connectors in the plug should be around 15 to 27 vdc.
 - B. Resistance check: Measure the resistance from the end of one molded plug lead to either of the two female connectors in the plug. One of the connectors should read close to zero ohms while the other should read infinity. Repeat with other wire. The same female connector as before should read zero while the other connector again reads infinity. Reverse polarity on the ohmmeter leads and repeat. The female connector that read infinity previously should now read close to zero ohms.
 - C. Replace plug if either of these test methods doesn't show the desired results.

OPERATION TEST

If the voltage, capacitor, overload and motor winding test fail to show the cause for failure:

 WARNING	
<p>HIGH VOLTAGE! DISCONNECT ALL POWER BEFORE SERVICING OR INSTALLING. MULTIPLE POWER SOURCES MAY BE PRESENT. FAILURE TO DO SO MAY CAUSE PROPERTY DAMAGE, PERSONAL INJURY OR DEATH.</p>	

1. Remove unit wiring from disconnect switch and wire a test cord to the disconnect switch.

NOTE: The wire size of the test cord must equal the line wire size and the fuse must be of the proper size and type.

2. With the protective terminal cover in place, use the three leads to the compressor terminals that were disconnected at the nearest point to the compressor and connect the common, start and run clips to the respective leads.
3. Connect good capacitors of the right MFD and voltage rating into the circuit as shown.
4. With power ON, close the switch.

 WARNING
LINE VOLTAGE NOW PRESENT.

- A. If the compressor starts and continues to run, the cause for failure is somewhere else in the system.
- B. If the compressor fails to start - replace.

LOCKED ROTOR TEST

If fuse, circuit breaker, ground fault protective device, etc. has tripped, this is a strong indication that an electrical problem exists and must be found and corrected. The circuit protective device rating must be checked and its maximum rating should coincide with that marked on the equipment nameplate.

Before checking for locked rotor, the compressor terminals should be checked for open windings (see Resistance Test) and the run capacitor and start capacitor (if used) should be checked thoroughly (see Checking Capacitor).

With power ON:

 WARNING
LINE VOLTAGE NOW PRESENT.

1. Check the serial data plate for the compressor locked rotor amps (LRA) rating.
2. Using an ampmeter, measure the amperage reading for the run and common wires to the compressor. Since the compressor motor overload will likely trip soon after drawing locked rotor amps, this measurement should be taken as soon as the compressor starts.
3. If the amperage reading roughly equals the compressor LRA rating and all other checks have been completed, locked rotor amps has been verified.

TESTING CRANKCASE HEATER (OPTIONAL ITEM)

The crankcase heater must be energized a minimum of four (4) hours before the condensing unit is operated.

Crankcase heaters are used to prevent migration or accumulation of refrigerant in the compressor crankcase during the off cycles and prevents liquid slugging or oil pumping on start up.

A crankcase heater will not prevent compressor damage due to a floodback or over charge condition.

SERVICING



WARNING

DISCONNECT ALL POWER BEFORE SERVICING.

1. Disconnect the heater lead in wires.
2. Using an ohmmeter, check heater continuity - should test continuous. If not, replace.

REFRIGERATION REPAIR PRACTICE



DANGER

ALWAYS REMOVE THE REFRIGERANT CHARGE IN A PROPER MANNER BEFORE APPLYING HEAT TO THE SYSTEM.

When repairing the refrigeration system:



WARNING

DISCONNECT ALL POWER BEFORE SERVICING.

1. Never open a system that is under vacuum. Air and moisture will be drawn in.
2. Plug or cap all openings.
3. Remove all burrs and clean the brazing surfaces of the tubing with sand cloth or paper. Brazing materials do not flow well on oxidized or oily surfaces.
4. Clean the inside of all new tubing to remove oils and pipe chips.
5. When brazing, sweep the tubing with dry nitrogen to prevent the formation of oxides on the inside surfaces.
6. Complete any repair by replacing the liquid line drier in the system, evacuate and charge.

BRAZING MATERIALS

Copper to Copper Joints - Sil-Fos used without flux (alloy of 15% silver, 80% copper, and 5% phosphorous). Recommended heat - 1400°F.

Copper to Steel Joints - Silver Solder used without a flux (alloy of 30% silver, 38% copper, 32% zinc). Recommended heat - 1200°F.

Aluminum to Aluminum & Copper to Aluminum Joints - ZA-1 Brazing Rods use Flux System Cesium-Based Polymer System (alloy of 78% Zinc and 22% Aluminum). Melting point 826°F Flow point 905°F.

STANDING PRESSURE TEST (RECOMMENDED BEFORE SYSTEM EVACUATION)



WARNING

TO AVOID THE RISK OF FIRE OR EXPLOSION, NEVER USE OXYGEN, HIGH PRESSURE AIR OR FLAMMABLE GASES FOR LEAK TESTING OF A REFRIGERATION SYSTEM.



WARNING

TO AVOID POSSIBLE EXPLOSION, THE LINE FROM THE NITROGEN CYLINDER MUST INCLUDE A PRESSURE REGULATOR AND A PRESSURE RELIEF VALVE. THE PRESSURE RELIEF VALVE MUST BE SET TO OPEN AT NO MORE THAN 450 PSIG.

Using dry nitrogen, pressurize the system to 450 PSIG. Allow the pressure to stabilize and hold for 15 minutes (minimum). If the pressure does not drop below 450 PSIG the system is considered leak free. Proceed to system evacuation using the Deep Vacuum Method. If after 15 minutes the pressure drops below 450 PSIG follow the procedure outlined below to identify system leaks. Repeat the Standing Pressure Test.

LEAK TESTING (NITROGEN OR NITROGEN-TRACED)



WARNING

TO AVOID THE RISK OF FIRE OR EXPLOSION, NEVER USE OXYGEN, HIGH PRESSURE AIR OR FLAMMABLE GASES FOR LEAK TESTING OF A REFRIGERATION SYSTEM.



WARNING

TO AVOID POSSIBLE EXPLOSION, THE LINE FROM THE NITROGEN CYLINDER MUST INCLUDE A PRESSURE REGULATOR AND A PRESSURE RELIEF VALVE. THE PRESSURE RELIEF VALVE MUST BE SET TO OPEN AT NO MORE THAN 450 PSIG.

Leak test the system using dry nitrogen and soapy water to identify leaks. If you prefer to use an electronic leak detector, charge the system to 10 PSIG with the appropriate system refrigerant (see Serial Data Plate for refrigerant identification). Do not use an alternative refrigerant. Using dry nitrogen finish charging the system to 450 PSIG. Apply the leak detector to all suspect areas. When leaks are discovered, repair the leaks, and repeat the pressure test. If leaks have been eliminated proceed to system evacuation.

SERVICING

SYSTEM EVACUATION

Condensing unit liquid and suction valves are closed to contain the charge within the unit. The unit is shipped with the valve stems closed and caps installed. Do not open valves until the system is evacuated.

 WARNING
REFRIGERANT UNDER PRESSURE! FAILURE TO FOLLOW PROPER PROCEDURES MAY CAUSE PROPERTY DAMAGE, PERSONAL INJURY OR DEATH.

NOTE: Scroll compressors should never be used to evacuate or pump down a heat pump or air conditioning system.

 CAUTION
PROLONGED OPERATION AT SUCTION PRESSURES LESS THAN 20 PSIG FOR MORE THAN 5 SECONDS WILL RESULT IN OVERHEATING OF THE SCROLLS AND PERMANENT DAMAGE TO THE SCROLL TIPS, DRIVE BEARINGS AND INTERNAL SEAL.

DEEP VACUUM METHOD (RECOMMENDED)

The Deep Vacuum Method requires a vacuum pump rated for 500 microns or less. This method is an effective and efficient way of assuring the system is free of non-condensable air and moisture. As an alternative, the Triple Evacuation Method is detailed in the Service Manual for this product model.

It is recommended to remove the Schrader Cores from the service valves using a core-removal tool to expedite the evacuation procedure.

1. Connect the vacuum pump, micron gauge, and vacuum rated hoses to both service valves. Evacuation must use both service valves to eliminate system mechanical seals.
2. Evacuate the system to less than 500 microns.
3. Isolate the pump from the system and hold vacuum for 10 minutes (minimum). Typically, pressure will rise slowly during this period. If the pressure rises to less than 1000 microns and remains steady, the system is considered leak-free; proceed to system charging and startup.
4. If pressure rises above 1000 microns but holds steady below 2000 microns, non-condensable air or moisture may remain or a small leak is present. Return to step 2: If the same result is achieved check for leaks and repair. Repeat the evacuation procedure.
5. If pressure rises above 2000 microns, a leak is present. Check for leaks and repair. Repeat the evacuation procedure.

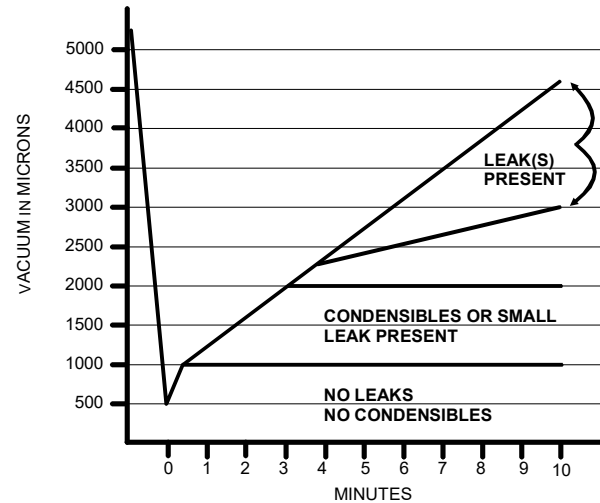

TRIPLE EVACUATION METHOD (ALTERNATE)

1. Evacuate the system to 4000 microns and hold for 15 minutes. Break the vacuum with dry nitrogen, bring the system pressure to 2-3 PSIG, and hold for 20 minutes. Release the nitrogen,
2. Evacuate to 1500 microns and hold for 20 minutes. Break the vacuum with dry nitrogen again, bring the system pressure back to 2-3 PSIG, and hold for 20 minutes.
3. Evacuate the system to 500 microns and hold for 60 minutes.
4. If the pressure rises to 1000 microns or less and remains steady the system is considered leak free; proceed to start-up.

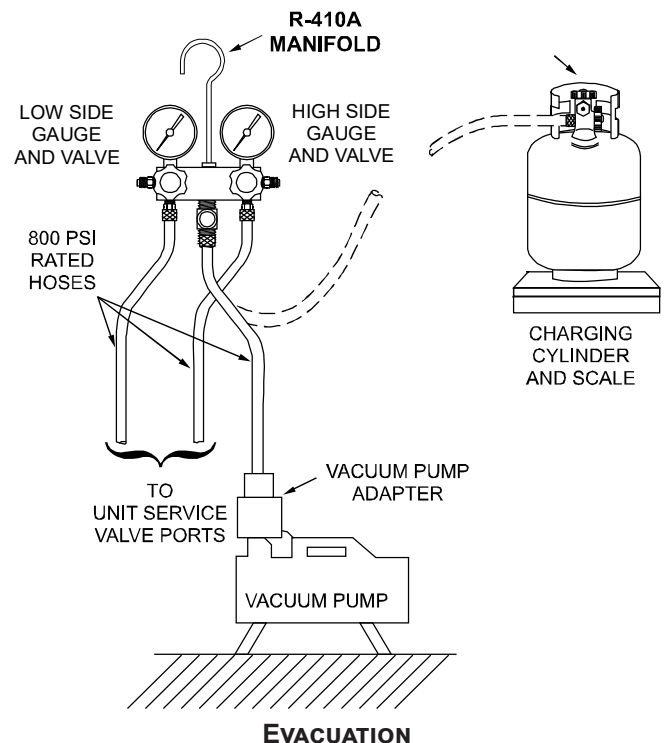

SERVICING

CHARGING

 WARNING
REFRIGERANT UNDER PRESSURE! <ul style="list-style-type: none">• DO NOT OVERCHARGE SYSTEM WITH REFRIGERANT.• DO NOT OPERATE UNIT IN A VACUUM OR AT NEGATIVE PRESSURE. FAILURE TO FOLLOW PROPER PROCEDURES MAY CAUSE PROPERTY DAMAGE, PERSONAL INJURY OR DEATH.

 CAUTION
ONLY USE REFRIGERANT CERTIFIED TO AHRI STANDARDS. USED REFRIGERANT MAY CAUSE COMPRESSOR DAMAGE. GOODMAN IS NOT RESPONSIBLE FOR DAMAGE OR THE NEED FOR REPAIRS RESULTING FROM THE USE OF UNAPPROVED REFRIGERANT TYPES OR USED OR RECYCLED REFRIGERANT. MOST PORTABLE MACHINES CANNOT CLEAN USED REFRIGERANT TO MEET AHRI STANDARDS.

 CAUTION
OPERATING THE COMPRESSOR WITH THE SUCTION VALVE CLOSED WILL CAUSE SERIOUS COMPRESSOR DAMAGE.

Charge the system with the exact amount of refrigerant.

See unit nameplate for the correct refrigerant charge amount.

An inaccurately charged system will cause future problems.

1. Using a charging scale, weigh in the refrigerant charge amount listed on unit nameplate. Allow liquid refrigerant only to enter the high side.
2. After the system will take all it will take, close the valve on the high side of the charging manifold.
3. Start the system and charge the balance of the refrigerant through the low side.

NOTE: R410A should be drawn out of the storage container or drum in liquid form due to its fractionation properties, but should be “Flashed” to its gas state before entering the system. There are commercially available restriction devices that fit into the system charging hose set to accomplish this. DO NOT charge liquid R410A into the compressor.

4. With the system still running, close the valve on the charging cylinder. At this time, you may still have some liquid refrigerant in the charging cylinder hose and will definitely have liquid in the liquid hose. Reseat the liquid line core. Slowly open the high side

manifold valve and transfer the liquid refrigerant from the liquid line hose and charging cylinder hose into the suction service valve port. CAREFUL: Watch so that liquid refrigerant does not enter the compressor.

Due to their design, Scroll compressors are inherently more tolerant of liquid refrigerant.

REFRIGERANT CHARGE CHECK (UNITS WITH FIXED ORIFICE DEVICES)

After completing airflow measurements and adjustments the unit's refrigerant charge must be checked. All package units with fixed orifice devices are charged using the super heat method at the compressor suction line.

After superheat is adjusted it is recommended to check unit subcooling at the condenser coil liquid line out.

(UNITS WITH TXV DEVICES)

All package units with TXV devices are charged using the SUBCOOLING method at the liquid line. After subcooling is checked it is recommended to check unit superheat at the evaporator coil suction line.

SUPERHEAT

Before checking the superheat or replacing the valve, perform all the procedures outlined under Air Flow, Refrigerant Charge, Expansion Valve - Overfeeding, Underfeeding. These are the most common causes for evaporator malfunction.

CHECKING SUPERHEAT

Refrigerant gas is considered superheated when its temperature is higher than the saturation temperature corresponding to its pressure. The degree of superheat equals the degrees of temperature increase above the saturation temperature at existing pressure.

Procedure:

1. Run system at least 15-20 minutes to allow pressure to stabilize.
2. Install a low side pressure gauge on the suction line access fitting.
3. Temporarily install thermometer on suction (large) line near compressor with adequate contact and insulate for best possible reading.
4. Record the gauge pressure corresponding temperature and the temperature of the suction line.
5. Refer to the superheat table for proper system superheat. Add charge to lower superheat recover charge to raise superheat.

SERVICING

Ambient Condenser Inlet Temp (°F Drybulb)	Return Air Temp. (°F Drybulb)				
	65	70	75	80	85
100	-	-	-	10	10
95	-	-	10	10	10
90	-	-	12	15	18
85	-	10	13	17	20
80	-	10	15	21	26
75	10	13	17	25	29
70	10	17	20	28	32
65	13	19	26	32	35
60	17	25	30	33	37

SUPERHEAT TABLE

EXAMPLE:

- A. Suction Pressure = 143
- B. Corresponding Temp. °F. = 50
- C. Thermometer on Suction Line = 59°F

To obtain the degrees temperature of superheat, subtract 50.0 from 59.0°F. The difference is 9° Superheat. The 9° Superheat would fall in the ± range of allowable superheat.

SUPERHEAT = SUCTION LINE TEMP - SAT. SUCTION TEMP.

CHECKING SUBCOOLING

Refrigerant liquid is considered subcooled when its temperature is lower than the saturation temperature corresponding to its pressure. The degree of subcooling equals the degrees of temperature decrease below the saturation temperature at the existing pressure.

Procedure:

1. Attach an accurate thermometer or preferably a thermocouple type temperature tester to the liquid line close to the pressure switch.
2. Install a high side pressure gauge on the liquid access fitting.
3. Record the gauge pressure and the temperature of the line.
4. The difference between the thermometer reading and pressure to temperature conversion is the amount of subcooling.

SUBCOOLING FORMULA = SAT. LIQUID TEMP. - LIQUID LINE TEMP.

EXAMPLE:

- A. Liquid Line Pressure = 417
- B. Corresponding Temp. °F. = 120°

- C. Thermometer on Liquid line = 109°F.
To obtain the amount of subcooling, subtract 109°F from 120°F. The difference is 11° subcooling. See the specification sheet or technical information manual for the design subcooling range for your unit.

See R410A Pressure vs. Temperature chart.

**EXPANSION VALVE (TXV) SYSTEM
TWO SPEED APPLICATION (*PUM3(61))**

Run the unit on high stage cooling for 15-20 minutes until refrigerant pressures stabilize. Check charge with unit on high stage.

Follow checking subcooling instructions

NOTE: The TXV provided is designed to meet the specification requirements for optimum product operation. "NO ADJUSTMENTS NEEDED TO TXV".

NOTE: Even though the compressor section of a scroll compressor is more tolerant of liquid refrigerant, continued floodback or flooded start conditions may wash oil from the bearing surfaces causing premature bearing failure.

CHECKING COMPRESSOR EFFICIENCY

The reason for compressor inefficiency is broken or damaged scroll flanks on Scroll compressors, reducing the ability of the compressor to pump refrigerant vapor.

The condition of the scroll flanks is checked in the following manner.

1. Attach gauges to the high and low side of the system.
2. Start the system and run a "Cooling Performance Test."

If the test shows:

- A. Below normal high side pressure.
- B. Above normal low side pressure.
- C. Low temperature difference across coil.
- D. Low amp draw at compressor.

And the charge is correct. The compressor is faulty - replace the compressor.

THERMOSTATIC EXPANSION VALVE

The expansion valve is designed to control the rate of liquid refrigerant flow into an evaporator coil in exact proportion to the rate of evaporation of the refrigerant in the coil. The amount of refrigerant entering the coil is regulated since the valve responds to temperature of the refrigerant gas leaving the coil (feeler bulb contact) and the pressure of the refrigerant in the coil.

SERVICING

This regulation of the flow prevents the return of liquid refrigerant to the compressor.

The three forces which govern the operation of the valve are: (1) the pressure created in the power assembly by the feeler bulb, (2) evaporator pressure, and (3) the equivalent pressure of the superheat spring in the valve.

0% bleed type expansion valves are used on the indoor coils. The 0% valve will not allow the system pressures (High and Low side) to equalize during the shut down period. The valve will shut off completely at approximately 100 PSIG Pressure.

Good thermal contact between the feeler bulb and the suction line is essential to satisfactory valve control and performance.

The bulb must be securely fastened to a clean straight section of the suction line. Application of the bulb to a horizontal run of line is preferred. If a vertical installation cannot be avoided the bulb should be mounted so that the capillary tubing comes out at the top.

THE VALVES PROVIDED ARE DESIGNED TO MEET THE SPECIFICATION REQUIREMENTS FOR OPTIMUM PRODUCT OPERATION. **DO NOT USE SUBSTITUTES.**

OVERFEEDING

Overfeeding by the expansion valve results in high suction pressure, cold suction line, and possible liquid slugging of the compressor.

If these symptoms are observed:

1. Check for an overcharged unit by referring to the cooling performance charts in the servicing section.
2. Check the operation of the power element in the valve as explained in Checking Expansion Valve Operation.
3. Check for restricted or plugged equalizer tube.

UNDERFEEDING

Underfeeding by the expansion valve results in low system capacity and low suction pressures.

If these symptoms are observed:

1. Check for a restricted liquid line or drier. A restriction will be indicated by a temperature drop across the drier.
2. Check the operation of the power element of the valve as described in Checking Expansion Valve Operation.



CAUTION

TO PREVENT PERSONAL INJURY, CAREFULLY CONNECT AND DISCONNECT MANIFOLD GAUGE HOSES. ESCAPING LIQUID REFRIGERANT CAN CAUSE BURNS. DO NOT VENT REFRIGERANT TO ATMOSPHERE. RECOVER DURING SYSTEM REPAIR OR FINAL UNIT DISPOSAL.

CHECKING EXPANSION VALVE OPERATION

1. Remove the remote bulb of the expansion valve from the suction line.
2. Start the system and cool the bulb in a container of ice water, closing the valve. As you cool the bulb, the suction pressure should fall and the suction temperature will rise.
3. Next warm the bulb in your hand. As you warm the bulb, the suction pressure should rise and the suction temperature will fall.
4. If a temperature or pressure change is noticed, the expansion valve is operating. If no change is noticed, the valve is restricted, the power element is faulty, or the equalizer tube is plugged.
5. Capture the charge, replace the valve and drier and evacuate.

FIXED ORIFICE RESTRICTOR DEVICES

The fixed orifice restrictor device (flowrator) used in conjunction with the indoor coil is a predetermined bore (I.D.).

It is designed to control the rate of liquid refrigerant flow into an evaporator coil.

The amount of refrigerant that flows through the fixed orifice restrictor device is regulated by the pressure difference between the high and low sides of the system.

In the cooling cycle when the outdoor air temperature rises, the high side condensing pressure rises. At the same time, the cooling load on the indoor coil increases, causing the low side pressure to rise, but at a slower rate.

Since the high side pressure rises faster when the temperature increases, more refrigerant flows to the evaporator, increasing the cooling capacity of the system.

When the outdoor temperature falls, the reverse takes place. The condensing pressure falls, and the cooling loads on the indoor coil decreases, causing less refrigerant flow.

A strainer is placed on the entering side of the tube to prevent any foreign material from becoming lodged inside the fixed orifice restriction device.

SERVICING

Pressure vs. Temperature Chart											
R-410A											
PSIG	°F	PSIG	°F	PSIG	°F	PSIG	°F	PSIG	°F	PSIG	°F
12	-37.7	114.0	37.8	216.0	74.3	318.0	100.2	420.0	120.7	522.0	137.6
14	-34.7	116.0	38.7	218.0	74.9	320.0	100.7	422.0	121.0	524.0	137.9
16	-32.0	118.0	39.5	220.0	75.5	322.0	101.1	424.0	121.4	526.0	138.3
18	-29.4	120.0	40.5	222.0	76.1	324.0	101.6	426.0	121.7	528.0	138.6
20	-36.9	122.0	41.3	224.0	76.7	326.0	102.0	428.0	122.1	530.0	138.9
22	-24.5	124.0	42.2	226.0	77.2	328.0	102.4	430.0	122.5	532.0	139.2
24	-22.2	126.0	43.0	228.0	77.8	330.0	102.9	432.0	122.8	534.0	139.5
26	-20.0	128.0	43.8	230.0	78.4	332.0	103.3	434.0	123.2	536.0	139.8
28	-17.9	130.0	44.7	232.0	78.9	334.0	103.7	436.0	123.5	538.0	140.1
30	-15.8	132.0	45.5	234.0	79.5	336.0	104.2	438.0	123.9	540.0	140.4
32	-13.8	134.0	46.3	236.0	80.0	338.0	104.6	440.0	124.2	544.0	141.0
34	-11.9	136.0	47.1	238.0	80.6	340.0	105.1	442.0	124.6	548.0	141.6
36	-10.1	138.0	47.9	240.0	81.1	342.0	105.4	444.0	124.9	552.0	142.1
38	-8.3	140.0	48.7	242.0	81.6	344.0	105.8	446.0	125.3	556.0	142.7
40	-6.5	142.0	49.5	244.0	82.2	346.0	106.3	448.0	125.6	560.0	143.3
42	-4.5	144.0	50.3	246.0	82.7	348.0	106.6	450.0	126.0	564.0	143.9
44	-3.2	146.0	51.1	248.0	83.3	350.0	107.1	452.0	126.3	568.0	144.5
46	-1.6	148.0	51.8	250.0	83.8	352.0	107.5	454.0	126.6	572.0	145.0
48	0.0	150.0	52.5	252.0	84.3	354.0	107.9	456.0	127.0	576.0	145.6
50	1.5	152.0	53.3	254.0	84.8	356.0	108.3	458.0	127.3	580.0	146.2
52	3.0	154.0	54.0	256.0	85.4	358.0	108.8	460.0	127.7	584.0	146.7
54	4.5	156.0	54.8	258.0	85.9	360.0	109.2	462.0	128.0	588.0	147.3
56	5.9	158.0	55.5	260.0	86.4	362.0	109.6	464.0	128.3	592.0	147.9
58	7.3	160.0	56.2	262.0	86.9	364.0	110.0	466.0	128.7	596.0	148.4
60	8.6	162.0	57.0	264.0	87.4	366.0	110.4	468.0	129.0	600.0	149.0
62	10.0	164.0	57.7	266.0	87.9	368.0	110.8	470.0	129.3	604.0	149.5
64	11.3	166.0	58.4	268.0	88.4	370.0	111.2	472.0	129.7	608.0	150.1
66	12.6	168.0	59.0	270.0	88.9	372.0	111.6	474.0	130.0	612.0	150.6
68	13.8	170.0	59.8	272.0	89.4	374.0	112.0	476.0	130.3	616.0	151.2
70	15.1	172.0	60.5	274.0	89.9	376.0	112.4	478.0	130.7	620.0	151.7
72	16.3	174.0	61.1	276.0	90.4	378.0	112.6	480.0	131.0	624.0	152.3
74	17.5	176.0	61.8	278.0	90.9	380.0	113.1	482.0	131.3	628.0	152.8
76	18.7	178.0	62.5	280.0	91.4	382.0	113.5	484.0	131.6	632.0	153.4
78	19.8	180.0	63.1	282.0	91.9	384.0	113.9	486.0	132.0	636.0	153.9
80	21.0	182.0	63.8	284.0	92.4	386.0	114.3	488.0	132.3	640.0	154.5
82	22.1	184.0	64.5	286.0	92.8	388.0	114.7	490.0	132.6	644.0	155.0
84	23.2	186.0	65.1	288.0	93.3	390.0	115.0	492.0	132.9	648.0	155.5
86	24.3	188.0	65.8	290.0	93.8	392.0	115.5	494.0	133.3	652.0	156.1
88	25.4	190.0	66.4	292.0	94.3	394.0	115.8	496.0	133.6	656.0	156.6
90	26.4	192.0	67.0	294.0	94.8	396.0	116.2	498.0	133.9	660.0	157.1
92	27.4	194.0	67.7	296.0	95.2	398.0	116.6	500.0	134.0	664.0	157.7
94	28.5	196.0	68.3	298.0	95.7	400.0	117.0	502.0	134.5	668.0	158.2
96	29.5	198.0	68.9	300.0	96.2	402.0	117.3	504.0	134.8	672.0	158.7
98	30.5	200.0	69.5	302.0	96.6	404.0	117.7	506.0	135.2	676.0	159.2
100	31.2	202.0	70.1	304.0	97.1	406.0	118.1	508.0	135.5	680.0	159.8
102	32.2	204.0	70.7	306.0	97.5	408.0	118.5	510.0	135.8	684.0	160.3
104	33.2	206.0	71.4	308.0	98.0	410.0	118.8	512.0	136.1	688.0	160.8
106	34.1	208.0	72.0	310.0	98.4	412.0	119.2	514.0	136.4	692.0	161.3
108	35.1	210.0	72.6	312.0	98.9	414.0	119.6	516.0	136.7	696.0	161.8
110	35.5	212.0	73.2	314.0	99.3	416.0	119.9	518.0	137.0		
112	36.9	214.0	73.8	316.0	99.7	418.0	120.3	520.0	137.3		

*Based on ALLIED SIGNAL Data

SERVICING

If a restriction should become evident, proceed as follows:

1. Recover refrigerant charge.
2. Remove the orifice or tube strainer assembly and replace.
3. Replace liquid line drier, evacuate and recharge.

CHECKING EQUALIZATION TIME

During the "OFF" cycle, the high side pressure bleeds to the low side through the fixed orifice restriction device.

Check equalization time as follows:

1. Attach a gauge manifold to the suction and liquid line dill valves.
2. Start the system and allow the pressures to stabilize.
3. Stop the system and check the time it takes for the high and low pressure gauge readings to equalize.

If it takes more than seven (7) minutes to equalize, the restrictor device is inoperative. Replace, install a liquid line drier, evacuate and recharge.

CHECKING RESTRICTED LIQUID LINE

When the system is operating, the liquid line is warm to the touch. If the liquid line is restricted, a definite temperature drop will be noticed at the point of restriction. In severe cases, frost will form at the restriction and extend down the line in the direction of the flow.

Discharge and suction pressures will be low, giving the appearance of an undercharged unit. However, the unit will have normal to high subcooling.

Locate the restriction, replace the restricted part, replace drier, evacuate and recharge.

OVERCHARGE OF REFRIGERANT

An overcharge of refrigerant is normally indicated by an excessively high head pressure.

An evaporator coil, using an expansion valve metering device, will basically modulate and control a flooded evaporator and prevent liquid refrigerant return to the compressor.

An evaporator coil, using a fixed orifice restrictor device (flowrator) metering device, could allow liquid refrigerant to return to the compressor under extreme overcharge conditions.

Also with a fixed orifice restrictor device (flowrator) metering device, extreme cases of insufficient indoor air can cause icing of the indoor coil and liquid refrigerant return to the compressor, but the head pressure would be lower.

There are other causes for high head pressure.

If other causes check out normal, an overcharge or a system containing non-condensables would be indicated.

If this system is observed:

1. Start the system.
2. Remove and capture small quantities of refrigerant as from the suction line access fitting until the head pressure is reduced to normal.
3. Observe the system while running a cooling performance test. If a shortage of refrigerant is indicated, then the system contains non-condensables.

NON-CONDENSABLES

If non-condensables are suspected, shut down the system and allow the pressures to equalize. Wait at least 15 minutes. Compare the pressure to the temperature of the coldest coil since this is where most of the refrigerant will be. If the pressure indicates a higher temperature than that of the coil temperature, non-condensables are present. Non-condensables are removed from the system by first removing the refrigerant charge, replacing and/or installing liquid line drier, evacuating and recharging.

Issue	Discharge Pressure	Suction Pressure	(Orifice) Superheat	(TXV) Subcooling	Temperature Split
Liquid Line Restriction	↓	↓	↑	↑	↓
System Undercharge	↓	↓	↑	↓	↓
System Overcharge	↑	↑	↓	↑	↓
Non Condensable	↑	↑	↑	↑	↓
Low Indoor Airflow	↓	↓	↓	↑	↑
Inefficient Compressor	↓	↑	↑	↓	↓

COMPRESSOR BURNOUT

When a compressor burns out, high temperature develops causing the refrigerant, oil and motor insulation to decompose forming acids and sludge.

If a compressor is suspected of being burned-out, attach a refrigerant hose to the liquid line dill valve and properly remove and dispose of the refrigerant.

 NOTICE
VIOLATION OF EPA REGULATIONS MAY RESULT IN FINES OR OTHER PENALTIES.

SERVICING

Now determine if a burn out has actually occurred. Confirm by analyzing an oil sample using a Sporlan Acid Test Kit, AK-3 or its equivalent.

Remove the compressor and obtain an oil sample from the suction stub. If the oil is not acidic, either a burnout has not occurred or the burnout is so mild that a complete clean-up is not necessary.

If acid level is unacceptable, the system must be cleaned by using the clean-up drier method.

**CAUTION**

DO NOT ALLOW THE SLUDGE OR OIL TO CONTACT THE SKIN. SEVERE BURNS MAY RESULT.

NOTE: The Flushing Method using R-11 refrigerant is no longer approved by Amana® Brand Heating-Cooling.

SUCTION LINE DRIER CLEAN-UP METHOD

The POE oils used with R410A refrigerant is an excellent solvent. In the case of a burnout, the POE oils will remove any burnout residue left in the system. If not captured by the refrigerant filter, they will collect in the compressor or other system components, causing a failure of the replacement compressor and/or spread contaminants throughout the system, damaging additional components.

The suction line filter drier should be installed as close to the compressor suction fitting as possible. The filter must be accessible and be rechecked for a pressure drop after the system has operated for a time. It may be necessary to use new tubing and form as required.

NOTE: At least twelve (12) inches of the suction line immediately out of the compressor stub must be discarded due to burned residue and contaminates.

1. Remove compressor discharge line strainer.
2. Remove the liquid line drier and expansion valve.
3. Purge all remaining components with dry nitrogen or carbon dioxide until clean.
4. Install new components including liquid line drier.
5. Braze all joints, leak test, evacuate, and recharge system.
6. Start up the unit and record the pressure drop across the drier.
7. Continue to run the system for a minimum of twelve (12) hours and recheck the pressure drop across the drier. Pressure drop should not exceed 6 PSIG.
8. Continue to run the system for several days, repeatedly checking pressure drop across the suction line drier. If the pressure drop never exceeds the 6 PSIG, the drier has trapped the contaminants.

9. Remove the suction line drier from the system.
9. If the pressure drop becomes greater, then it must be replaced and steps 5 through 9 repeated until it does not exceed 6 PSIG.

NOTICE: Regardless, the cause for burnout must be determined and corrected before the new compressor is started.

CHECKING EXTERNAL STATIC PRESSURE

The minimum and maximum allowable duct static pressure is found in the Technical Information Manual.

Too great of an external static pressure will result in insufficient air that can cause icing of the coil, whereas too much air can cause poor humidity control, and condensate to be pulled off the evaporator coil causing condensate leakage. Too much air can cause motor overloading and in many cases this constitutes a poorly designed system. To determine proper air movement, proceed as follows:

1. Using a digital manometer measure the static pressure of the return duct at the inlet of the unit, (Negative Pressure).

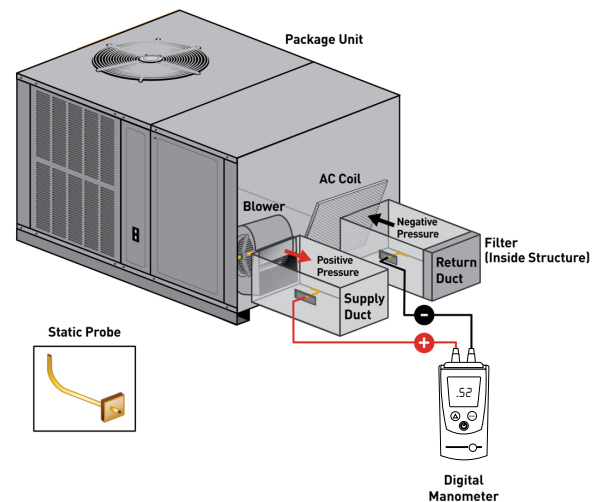

TOTAL EXTERNAL STATIC

2. Measure the static pressure of the supply duct, (Positive Pressure).
3. Add the two readings together.

NOTE: Both readings may be taken simultaneously and read directly on the manometer if so desired.

4. Consult proper table for quantity of air.

If the external static pressure exceeds the minimum or maximum allowable statics, check for closed dampers, dirty filters, undersized or poorly laid out ductwork.

SERVICING

AIRFLOW ADJUSTMENTS

A/GPUM3 models are equipped with EEM motors. Adjust the CFM for the unit by changing the 24V low voltage leads to the speed terminal block on the motor.

FAN ONLY			HEATING			COOLING		
SPEED TAP	DEFINITION	LEAD COLOR	SPEED TAP	DEFINITION	LEAD COLOR	SPEED TAP	DEFINITION	LEAD COLOR
T1	Fan Only	Green	T2	High Speed		T4	Low Speed	Yellow
			T3	Low Speed	White	T5	High Speed	

SINGLE STAGE MODELS

FAN ONLY			HEATING			COOLING		
SPEED TAP	DEFINITION	LEAD COLOR	SPEED TAP	DEFINITION	LEAD COLOR	SPEED TAP	DEFINITION	LEAD COLOR
T1	Fan Only	Green	T2	Heat	White	T3	Low Speed	Purple
						T4	High Speed	Yellow
						T5	High Speed Hi-Static	

TWO STAGE MODELS

CHECKING TEMPERATURE RISE

Temperature rise is related to the BTUH output of the unit and the amount of air (CFM) circulated over the heat exchanger.

All units are designed for a given range of temperature increase. This is the temperature of the air leaving the unit minus the temperature of the air entering the unit.

The more air (CFM) being delivered through a given unit the less the rise will be; so the less air (CFM) being delivered, the greater the rise. The temperature rise should be adjusted in accordance to a given unit specifications and its external static pressure.

1. Check BTUH input to unit do not exceed input rating stamped on rating plate.
2. Take entering and leaving air temperatures.
3. Select the proper speed tap or dip switch setting for direct drive units.
4. Take motor amperage draw to determine that the motor is not overloaded during adjustments.

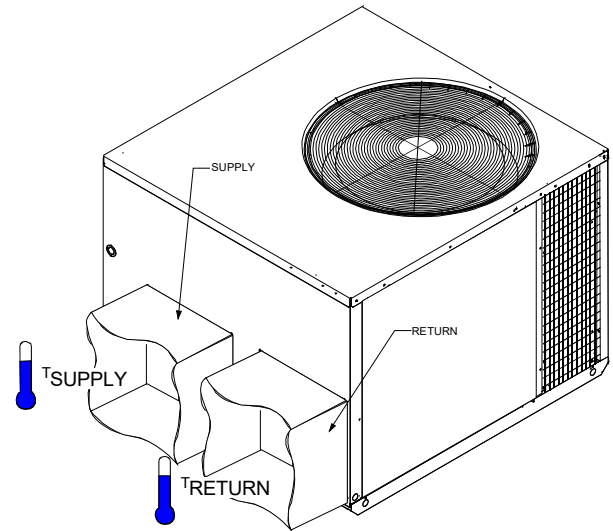

$$\text{RISE} = T_{\text{SUPPLY}} - T_{\text{RETURN}}$$

CHECKING TEMPERATURE RISE

TESTING PRIMARY LIMIT CONTROL

*PU units use a snap-disk type primary limit device. Sometimes referred to as "stat on a stick". The limit setting is fixed and must not be readjusted in the field.

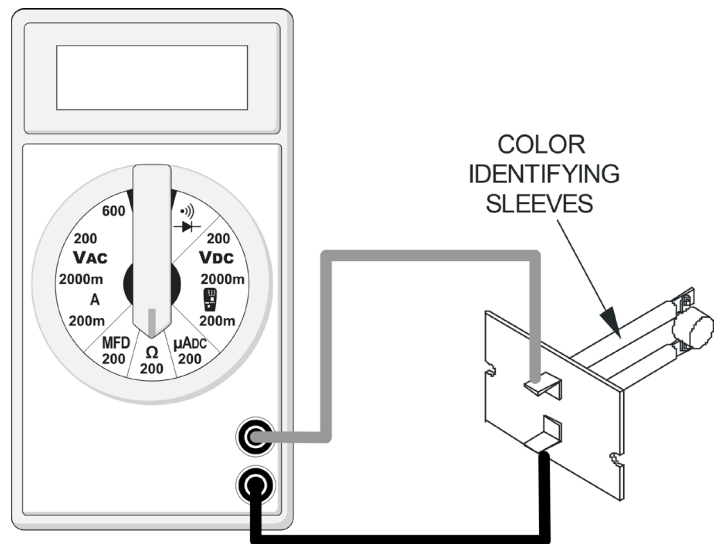

TESTING PRIMARY LIMIT CONTROL

Refer to the specification section to determine the proper limit cutout temperature for the model being serviced.

In all instances the limit control is wired in series with the ignition control.

If the temperature within the furnace should exceed this setting, the control will open, de-energizing the ignition control which in turn will open the electrical circuit to the gas valve.

SERVICING

The control will automatically reset when the temperature within the combustion chamber is sufficiently lowered.

WARNING

HIGH VOLTAGE!
DISCONNECT ALL POWER BEFORE SERVICING OR INSTALLING. MULTIPLE POWER SOURCES MAY BE PRESENT. FAILURE TO DO SO MAY CAUSE PROPERTY DAMAGE, PERSONAL INJURY OR DEATH.



WARNING

DO NOT BYPASS SAFETY DEVICES.

1. Remove electrical power to unit. Some units may have more than one source of power.
2. Remove the wires from the limit control terminals.
3. Using an ohmmeter, test for continuity across the two terminals.
4. If limit test open allow unit to cool and retest.
5. If still open, replace the control.

TESTING AUXILIARY LIMIT

The auxiliary limit control is a preset nonadjustable control mounted in the blower compartment area.

It is connected in series with the burner temperature switch wiring to the gas valve. If its temperature should be exceeded, it will open, interrupting the voltage to the gas valve causing it to open.

An additional limit (primary limit) control is required for safety control of high temperature within the furnace or ductwork.

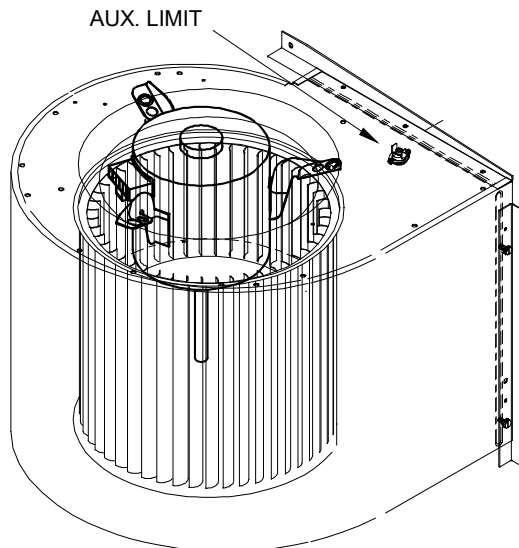



WARNING

HIGH VOLTAGE!
DISCONNECT ALL POWER BEFORE SERVICING OR INSTALLING. MULTIPLE POWER SOURCES MAY BE PRESENT. FAILURE TO DO SO MAY CAUSE PROPERTY DAMAGE, PERSONAL INJURY OR DEATH.

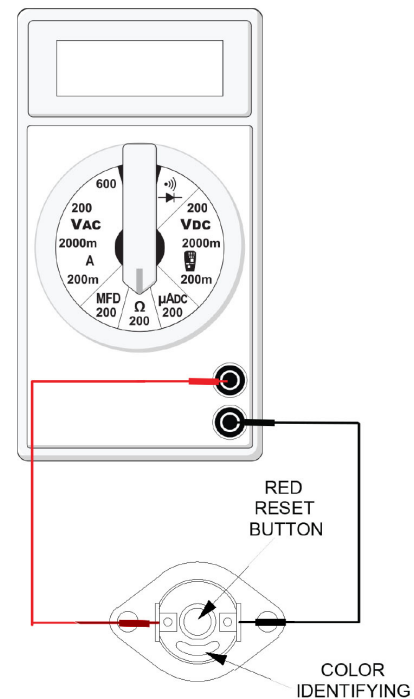

1. Remove the wires from the auxiliary limit control terminals.
2. Using an ohmmeter, test for continuity across the two terminals. No reading indicates the control is open. Push the red reset button, test again - if still open, replace the control.



TESTING AUXILIARY LIMIT CONTROL

CHECKING BURNER TEMPERATURE SWITCH

*PU units are equipped with a temperature-activated auto reset control. This control is mounted to the burner box assembly and is wired in series with the auxiliary limit and gas valve. The control is designed to open should the temperature exceed the designed box temperature. An over firing condition or flame impingement on the heat shield can also cause the control to open.

SERVICING

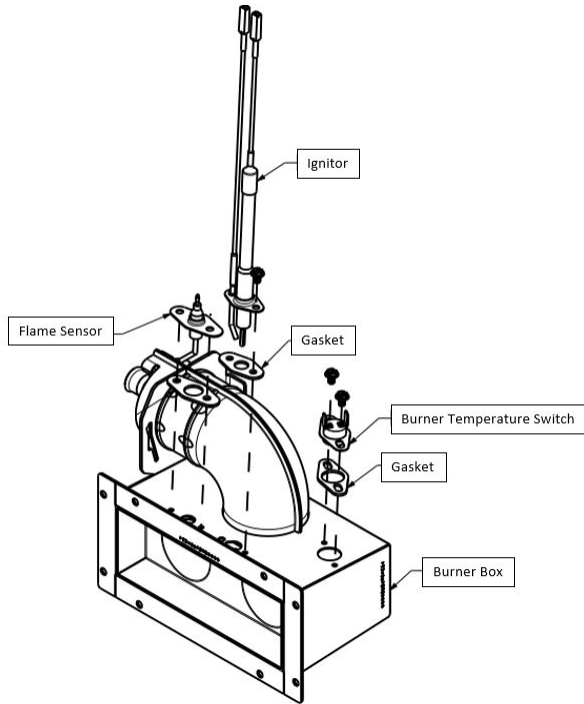

If the burner temperature switch has opened, the circuit between the ignition control and gas valve will be interrupted and the ignition control module will go into lockout. The servicer should reset the ignition control by opening and closing the thermostat circuit. The servicer should look for the ignitor sparking which indicates there is power to the ignition control. The servicer should measure the voltage between each side of the burner temperature switch and ground while the ignition control is attempting to power the gas valve.

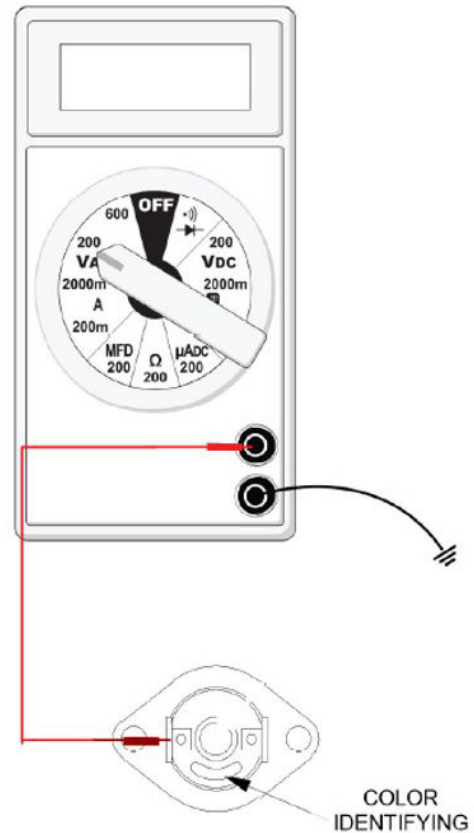

CHECKING BURNER LIMIT SWITCH

LIMIT SWITCH OPERATION (APPLIES TO PRIMARY, AUXILIARY, AND BURNER LIMIT SWITCH LIMITS) DSI SYSTEMS



If a limit switch opens, the indoor blower is energized on heat speed and the induced draft blower is energized. The LED on the control flashes "4" to indicate an open limit switch. The blower and inducer remain on while the limit switch is open. The gas valve is de-energized. Power to the thermostat "R" is removed while the limit switch is open. When the limit switch re-closes, the induced draft motor runs through its post purge and the indoor blower goes through the heat off delay.

If a call for heat exists when the limit switch re-closes, the control goes through a pre-purge period and then makes an ignition attempt. The indoor blower remains on (for the delay off time) during the re-ignition attempt.

1. If no voltage is measured on either side of control it indicates ignition control or wiring to control problem.
2. If voltage is measured on one side of the control and not the other, it indicates the control is open.
3. If voltage is measured on both sides of the control the wiring to gas valve or valve is at fault.

SERVICING

TESTING INDUCER MOTOR

 WARNING
<p>HIGH VOLTAGE! DISCONNECT ALL POWER BEFORE SERVICING OR INSTALLING. MULTIPLE POWER SOURCES MAY BE PRESENT. FAILURE TO DO SO MAY CAUSE PROPERTY DAMAGE, PERSONAL INJURY OR DEATH.</p> 

1. Disconnect the motor wire leads from its connection point at integrated ignition control module.
2. Using an ohmmeter, test for continuity between each of the motor leads.
3. Touch one probe of the ohmmeter to the motor frame (ground) and the other probe in turn to each lead.

If the windings do not test continuous or a reading is obtained to ground, replace the motor.

4. After completing check and/or replacement of induced draft blower motor.
5. Turn on electrical power and verify proper unit operation.

INDUCER MOTOR VOLTAGE CHECK

The motor will have line voltage present whenever the unit is energized.

Verify voltage by checking the voltage between the black and white wires at harness.

INDUCER MOTOR OPERATION TEST

To test the operation of the motor, initiate test mode at PCBBL216 PCB and verify that the motor is producing the correct amount of negative draft during the inducer 2.0" w.c. 60 second 2.0" run period.

(See "Field Test Mode" section for guidance on executing Field Test Mode.)

TESTING GAS VALVE

DIRECT SPARK IGNITION (DSI) SYSTEMS

A combination redundant operator type gas valve which provides all manual and automatic control functions required for gas fired heating equipment is used on single stage models.

 WARNING
DISCONNECT GAS AND ELECTRICAL POWER SUPPLY.

CHECKING GAS PRESSURE

Gas inlet and manifold pressures should be checked and adjusted in accordance to the type of fuel being consumed.

 WARNING
DISCONNECT GAS AND ELECTRICAL POWER SUPPLY.

NOTE: Use adapter kit 0151K0000S to measure gas pressure on White-Rodgers 36J22 gas valves.

1. Connect a digital manometer or adequate gauge to the inlet pressure fitting of the gas valve.
2. Remove the pressure tap fitting at the manifold if provided or check at the gas valve outlet fitting and connect another manometer or gauge.

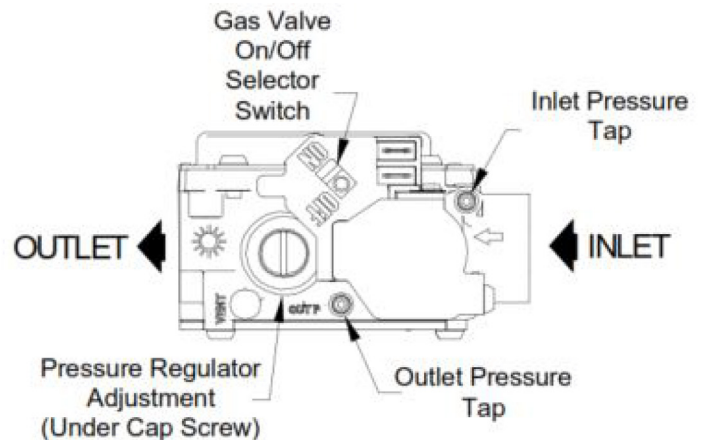

WHITE RODGERS MODEL 36J22 GAS VALVE

MEASURING INLET AND MANIFOLD GAS PRESSURE

With power ON:

 WARNING
LINE VOLTAGE NOW PRESENT.

3. Put furnace into heating cycle and turn on all other gas consuming appliances.
 - A. Inlet pressure should be a nominal 7" w.c.
 - B. Measure gas manifold pressure with burners firing. Adjust manifold pressure using the table below.

Manifold Gas Pressure	
Natural Gas	2.8" - 3.2" w.c.

SERVICING

If operating pressures differ from above, make necessary pressure regulator adjustments, check piping size, etc., and/or consult with local utility.

CHECKING PRESSURE TRANSDUCER

NOTE: *PU3M models utilize a pressure transducer (in place of a pressure switch).

The pressure transducer is a pressure sensing device that allows the control to modulate the inducer motor through the heating cycle. The transducer contains electronic circuitry and must not be subjected to any voltage source other than factory wiring. Refer to the Troubleshooting chart beginning on page 36 for diagnosing suspected issues.

Sensing Range Specification: 0.0-4.0 inches W.C.

Voltage Specifications:

- Steady State: 5.0 vDC from red to green wire (transducer wiring harness input)
- With Inducer off: 0.5 vDC from black to green wire (transducer wiring harness output).
- During operation: Output range equals 0.5 - 4.5 vDC

Potential Errors:

1. Control board does not receive 0.25 vDC for inducer motor with motor off
 - A. Will result in 2-flash error code on the control board
2. Control board does not receive the required voltage change (0.5 - 4.5 vDC) during inducer motor operation.
 - A. Will result in 3-flash error code on the control board

Pressure Sensor: The pressure sensor is mounted near induced draft blower. Its function is to regulate the induced draft blower's speed in order to maintain proper air-fuel ratio for clean and reliable combustion. The pressure sensor also guards against insufficient airflow (combustion air and flue products) through the heat exchanger.

The pressure sensor should read approximately -2.5 in. w.c. for the 40,000 BTU/hr models, -2.2 in. w.c. for the 60,000 BTU/hr models and -1.9 in. w.c. for the 80,000 BTU/hr models.

**WARNING**

HIGH VOLTAGE!
DISCONNECT ALL POWER BEFORE SERVICING OR INSTALLING. MULTIPLE POWER SOURCES MAY BE PRESENT. FAILURE TO DO SO MAY CAUSE PROPERTY DAMAGE, PERSONAL INJURY OR DEATH.



FIELD TEST MODE

Function: When the SW1 button is pressed and held until the LED is blinking in AMBER (more than 10 seconds, less than 15 seconds), the control will execute a field test mode sequence to cycle through component operation.

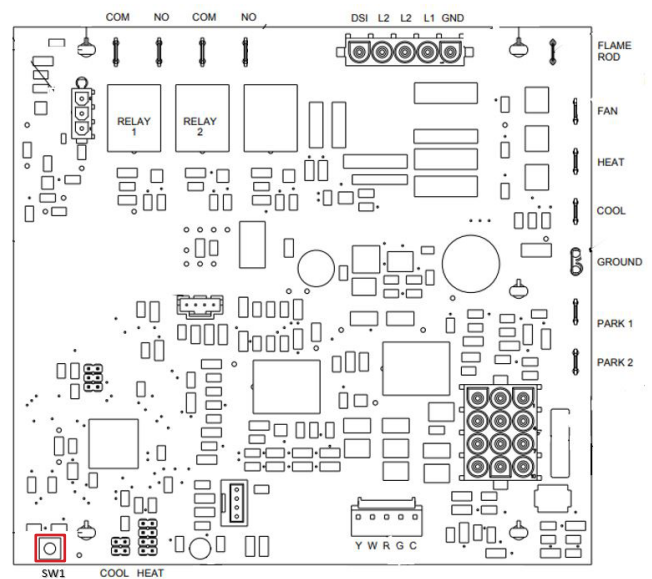

Operation: The control must be powered and the thermostat satisfied (no call for heat or cool). Depress and hold the SW1 button for more than 10 seconds, but less than 15 seconds until the LED is blinking in AMBER, then release. The control will execute the following functions:

1. Inducer - "Run" setting throughout the test
2. Igniter (DSI) - ON for 15 seconds
3. Blower - "Fan" Speed for 15 seconds
4. Blower - "Heat" Speed for 15 seconds
5. Blower - "Cool" Speed for 15 seconds
6. Return to OFF mode

Once the Field Test Mode is initiated, all thermostat inputs will be ignored until the field test sequence is completed. If the SW1 button is held for more than 15 seconds, the button press will be ignored, and the LED display will return to its prior state.

SERVICING

CHECKING INTEGRATED IGNITION CONTROL BOARD

NOTE: Failure to earth ground the unit, or a high resistance connection in the ground may cause the control to lockout due to failure to sense flame. The ground wire must run from the unit ground to the electrical panel ground.



WARNING

TO AVOID PERSONAL INJURY OR DEATH DUE TO ELECTRIC SHOCK, WIRING TO THE UNIT MUST BE PROPERLY GROUNDED. DISCONNECT POWER BEFORE INSTALLING OR SERVICING.

The ignition control is a combination electronic and electromechanical device and is not field repairable.

The tests below must be completed within a given time frame due to the operation of the ignition control.

1. Check for 230 volts from Line 1 to Line 2 at the ignition control.
2. Check for 24 volts from W to C terminals on the ignition control. If no voltage, check transformer, room thermostat and wiring.
If you have 24 volts coming off the transformer, but have approximately 13 volts between C and R, check for blown fuse.
3. Check for 230 volts to the induced draft blower by measuring voltage between Pins 4 & 5 on 5-pin connector.
4. If voltage is present in Steps 1 through 3 and the induced draft blower is operating, check for spark igniter and 24 volts to gas valve.

CHECKING FOR DELAYED IGNITION

Delayed ignition is a delay in lighting a combustible mixture of gas and air which has accumulated in the combustion chamber.

When the mixture does ignite, it may explode and/or rollout causing burning in the burner venturi.

If delayed ignition should occur, the following should be checked:

1. Improper gas pressure - Adjust to proper pressure.
Improper burner positioning - Burners should be in locating slots, level front to rear and left to right.
2. Carry over (lighter tube or cross lighter) obstructed - Clean.
3. Main burner orifice(s) deformed, or out of alignment to burner - Replace.

CHECKING FLAME SENSOR

A flame sensing device is used in conjunction with the ignition control module to prove combustion. If a microamp signal is not present the control will de-energize the gas valve and "retry" for ignition or lockout.

DSI DIRECT SPARK IGNITION SYSTEMS



WARNING

**HIGH VOLTAGE!
DISCONNECT ALL POWER BEFORE SERVICING OR INSTALLING. MULTIPLE POWER SOURCES MAY BE PRESENT. FAILURE TO DO SO MAY CAUSE PROPERTY DAMAGE, PERSONAL INJURY OR DEATH.**



1. Disconnect the flame sensor wire from terminal FS of the ignition control module.
2. Connect a microamp meter in series with this wire and terminal FS.
3. Be sure the negative side of the meter is to the wire and the positive of the meter is to terminal FS.
4. Turn on Power.



WARNING

LINE VOLTAGE NOW PRESENT.

5. With Power ON, Place the unit into a heating cycle.
6. As soon as flame is established a microamp reading should be evident once proof of flame (microamp reading) is established, the spark ignitor will be de-energized.
7. The nominal microamp reading is 10 microamps.
8. If the microamp current is less than 3.0 microamp the control will lockout and flash a code of 1 Amber flash after attempting to reestablish flame sense.
9. If the microamp reading is less than the minimum specified, check for high resistance wiring connections, the distance (3/16") between the sensor and burner, flame sensor connections, dirty flame sensor or poor grounding.
10. If no reading, check for continuity on all components and if good - Replace ignition control module.

NOTE: Contaminated fuel or combustion air can create a nearly invisible coating on the flame sensor. This coating works as an insulator causing a loss in the flame sense signal. If this situation occurs the flame sensor must be cleaned with steel wool. Do not use sandpaper, the silicone in sandpaper will further contaminate the sensor.

BLOWER PERFORMANCE DATA

A/GPUM32404041 - Rise Range: 25° - 55°													
E.S.P.	T1 FAN ONLY SPEED			T2 HEATING SPEED			T3 HEATING SPEED			T4 COOLING SPEED		T5 COOLING SPEED	
	CFM	WATTS	RISE	CFM	WATTS	RISE	CFM	WATTS	RISE	CFM	WATTS	CFM	WATTS
0.1	700	76	48	1080	197	42	733	65	34	1020	153	1119	208
0.2	665	84	51	1032	204	44	703	74	36	985	160	1110	216
0.3	614	91	55	988	212	46	664	83	38	946	168	1083	222
0.4	561	98	60	948	220	47	604	91	41	905	175	1052	229
0.5	505	105	67	902	225	50	536	98	44	863	183	1017	237
0.6	438	114	77	859	231	52	483	105	49	813	190	979	243
0.7	374	119	90	813	238	55	430	111	X	759	199	934	250
0.8	318	125	106	770	245	58	381	119	X	701	206	879	259

A/GPUM33006041 - Rise Range: 30° - 60°													
E.S.P.	T1 FAN ONLY SPEED		T2 HEATING SPEED			T3 HEATING SPEED			T4 COOLING SPEED		T5 COOLING SPEED		
	CFM	WATTS	CFM	WATTS	RISE	CFM	WATTS	RISE	CFM	WATTS	CFM	WATTS	
0.1	891	113	1196	190	34	891	113	44	1202	246	1285	278	
0.2	831	119	1147	197	36	831	119	46	1173	251	1238	284	
0.3	780	127	1102	204	37	780	127	47	1143	258	1189	293	
0.4	714	135	1054	212	38	714	135	50	1110	265	1146	300	
0.5	639	146	1009	221	39	639	146	54	1073	272	1105	306	
0.6	555	153	955	230	40	555	153	60	1035	278	1058	314	
0.7	502	159	897	238	41	502	159	X	994	285	1011	324	
0.8	444	165	828	245	42	444	165	X	947	293	948	329	

A/GPUM3606041 - Rise Range: 30° - 60°													
E.S.P.	T1 FAN ONLY SPEED		T2 HEATING SPEED			T3 HEATING SPEED			T4 COOLING SPEED		T5 COOLING SPEED		
	CFM	WATTS	CFM	WATTS	RISE	CFM	WATTS	RISE	CFM	WATTS	CFM	WATTS	
0.1	870	107	1216	228	31	870	107	42	1448	342	1533	408	
0.2	792	118	1149	234	32	792	118	44	1403	343	1470	419	
0.3	685	130	1083	246	33	685	130	48	1358	354	1416	428	
0.4	623	138	1014	252	34	623	138	51	1319	361	1360	434	
0.5	549	143	919	265	38	549	143	54	1277	366	1307	446	
0.6	479	144	850	272	41	479	144	55	1232	376	1247	455	
0.7	411	155	781	280	43	411	155	58	1176	386	1177	468	
0.8	343	161	717	285	44	343	161	X	1120	395	1104	478	

A/GPUM34208041 - Rise Range: 30° - 60°													
E.S.P.	T1 FAN ONLY SPEED		T2 HEATING SPEED			T3 HEATING SPEED			T4 COOLING SPEED		T5 COOLING SPEED		
	CFM	WATTS	CFM	WATTS	RISE	CFM	WATTS	RISE	CFM	WATTS	CFM	WATTS	
0.1	1090	146	1363	249	40	1304	221	43	1542	392	1637	444	
0.2	1024	156	1305	256	42	1242	230	45	1494	403	1593	454	
0.3	960	165	1247	269	45	1185	241	46	1437	409	1541	459	
0.4	867	173	1189	276	46	1126	249	49	1392	419	1497	473	
0.5	791	183	1130	285	48	1054	258	52	1342	430	1450	478	
0.6	710	191	1048	294	50	967	270	54	1295	440	1407	485	
0.7	644	196	966	305	52	899	278	56	1238	447	1357	493	
0.8	587	206	901	315	54	832	285	59	1183	454	1304	502	

X = Not recommended for heat application

BLOWER PERFORMANCE DATA

A/GPUM34808041 - Rise Range: 30° - 60°												
E.S.P.	T1 FAN ONLY SPEED		T2 HEATING SPEED			T3 HEATING SPEED			T4 COOLING SPEED		T5 COOLING SPEED	
	CFM	WATTS	CFM	WATTS	RISE	CFM	WATTS	RISE	CFM	WATTS	CFM	WATTS
0.1	1090	146	1363	249	40	1304	221	43	1851	679	1928	626
0.2	1024	156	1305	256	42	1242	230	45	1803	688	1874	639
0.3	960	165	1247	269	45	1185	241	46	1754	696	1836	647
0.4	867	173	1189	276	46	1126	249	49	1706	702	1780	658
0.5	791	183	1130	285	48	1054	258	52	1665	710	1735	671
0.6	710	191	1048	294	50	967	270	54	1619	719	1683	677
0.7	644	196	966	305	52	899	278	56	1573	727	1629	686
0.8	587	206	901	315	54	832	285	59	1528	739	1578	693

A/GPUM36108041 - Rise Range: 30° - 60°												
E.S.P.	T1 FAN ONLY SPEED		T2 HEATING SPEED			T3 LOW STAGE		T4 HIGH STAGE		T5 COOLING SPEED		
	CFM	WATTS	CFM	WATTS	RISE	CFM	WATTS	CFM	WATTS	CFM	WATTS	
0.1	1156	158	1283	200	42	1420	284	2044	757	2107	831	
0.2	1077	163	1224	210	44	1371	294	1996	770	2060	837	
0.3	1015	172	1152	216	46	1318	302	1955	779	2015	850	
0.4	930	179	1098	228	49	1268	313	1913	785	1972	858	
0.5	839	193	1025	236	51	1217	326	1871	796	1930	864	
0.6	759	200	945	249	53	1163	341	1828	803	1888	875	
0.7	697	206	867	264	56	1101	347	1788	809	1850	885	
0.8	632	216	806	271	61	1041	358	1742	822	1805	889	

X = Not recommended for heat application

TROUBLESHOOTING

PCBBL216 ULN CONTROL ERROR CODES					
LED ACTIVITY	DESCRIPTION	COLOR	MINIMUM LOCKOUT PERIOD	POSSIBLE CAUSES	CORRECTIVE ACTIONS
LED OFF	NO 24 VAC POWER TO CONTROL	N/A	N/A	<ul style="list-style-type: none"> No 240 volt power to unit or 24 volt power to control module. 	<ul style="list-style-type: none"> Confirm 240- and 24-volt power to integrated control board. Check for possible shorts in 240- and 24-volt circuits. Repair as necessary.
RED, AMBER, GREEN	POWER-UP VERIFICATION OF LED	N/A	N/A		
STEADY ON	CONTROL FAULT DETECTED	RED	1 HOUR OR HARD LOCKOUT	<ul style="list-style-type: none"> Relay failure, memory failure or hardware failure 	<ul style="list-style-type: none"> Inspect wiring connections from control board to all key component for damage or mis-wiring. Check gas valve, induced draft motor, transformer and other components for damaged, defective or grounded component. Replace bad integrated control module.
1 FLASH	RETRIES EXCEEDED	RED	1 HOUR FIXED	<ul style="list-style-type: none"> Lockout due to 3 ignition attempt retries. 	<ul style="list-style-type: none"> Check inlet and outlet gas pressure at gas valve. Check flame sensor signal. Clean sensor if coated and/or oxidized. Check unit ground wiring.
2 FLASHES	PRESSURE SENSOR NULL ERROR	RED	5 MINUTES	<ul style="list-style-type: none"> With inducer off (no call for heat), pressure sensor gets feedback from inducer when it should be zero. 	<ul style="list-style-type: none"> Check inducer to confirm it is not operating. Check inducer and pressure sensor for loose hose. Check pressure sensor wiring and correct wiring as needed. Replace pressure sensor if faulty.
3 FLASHES	PRESSURE SENSOR SPAN ERROR	RED	5 MINUTES	<ul style="list-style-type: none"> Inducer not maintaining pressure setting. 	<ul style="list-style-type: none"> Check pressure sensor hose for blocked or pinched hose or improper connection. Check wiring connections. Replace pressure sensor if faulty.
4 FLASHES	HIGH LIMIT SWITCH OPEN	RED	MAXIMUM RECOVERY TIME 1 HOUR AFTER MAX TRIPS EXCEEDED	<ul style="list-style-type: none"> Primary limit or auxiliary limit circuit is open. 	<ul style="list-style-type: none"> Check circulator blower speed and performance. Check filters and ductwork for any restrictions. Check external static pressure for undersized duct system. Check primary limit. Check wiring connections.
5 FLASHES	FLAME PRESENT WITH GAS VALVE OFF	RED	5 MINUTES	<ul style="list-style-type: none"> Faulty control module. 	<ul style="list-style-type: none"> Replace bad integrated control module.
6 FLASHES	NORMALLY CLOSED BLOCKED BURNER SWITCH / AUXILIARY SWITCH OPEN	RED	MAXIMUM RECOVERY TIME 1 HOUR IF TIME EXCEEDED	<ul style="list-style-type: none"> Burner temperature limit switch open. 	<ul style="list-style-type: none"> Excessive flame - check inlet and outlet gas pressure at gas valve. Check induced draft blower for proper performance. Check wiring connections.
7 FLASHES	GAS VALVE CIRCUIT SHORTED	RED	1 HOUR	<ul style="list-style-type: none"> Bad wiring. Faulty control module. 	<ul style="list-style-type: none"> Inspect wiring for damage or mis-wiring. Repair/replace as needed. Replace bad integrated control module.
8 FLASHES	RESERVED	RED	N/A		
10 FLASHES	HIGH LIMIT SWITCH RECOVERY TIMER EXPIRED	RED	1 HOUR OR HARD LOCKOUT	<ul style="list-style-type: none"> Primary or burner limit did not reset within specified time period. 	<ul style="list-style-type: none"> Check gas valve outlet pressure for over-firing. Check blower fan speed for correct speed setting. Check filters and ductwork for any restrictions. Check external static pressure for undersized duct system.

TROUBLESHOOTING

LED ACTIVITY	DESCRIPTION	COLOR	MINIMUM LOCKOUT PERIOD	POSSIBLE CAUSES	CORRECTIVE ACTIONS
STEADY ON	OEM FACTORY TEST MODE	AMBER	N/A		
RAPID FLASH	FIELD TEST MODE	AMBER	N/A		
1 FLASH	LOW FLAME SENSE	AMBER	N/A	<ul style="list-style-type: none"> • Flame sensor incorrectly positioned in burner flame. • Flame sensor is coated and/or oxidized. • Improper gas pressure of combustion air. 	<ul style="list-style-type: none"> • Inspect for proper sensor alignment. • Clean flame rod. • Compare gas pressure to rating plate info. Adjust as needed.
2 FLASHES	ID PLUG FAILURE	AMBER	HARD LOCKOUT HEATING MODE	<ul style="list-style-type: none"> • Improper ID plug. 	<ul style="list-style-type: none"> • Replace ID plug.
3 FLASHES	CONTROL FUSE OPEN	AMBER	5 MINUTES	<ul style="list-style-type: none"> • Blown fuse. 	<ul style="list-style-type: none"> • Inspect wiring for damage, mis-wiring or short to ground. • Replace integrated control module fuse (3A).
STEADY ON	STANDBY NORMAL OPERATION NO THERMOSTAT CALL	GREEN	N/A		
RAPID FLASH	CLEAR ERROR HISTORY	GREEN	N/A		
1 FLASH	CALL FOR HEATING	GREEN	N/A		
2 FLASHES	CALL FOR COOLING	GREEN	N/A		
3 FLASHES	CONTINUOUS FAN OPERATION	GREEN	N/A		

TROUBLESHOOTING

TROUBLESHOOTING

IGNITION CONTROL ERROR CODES

The following presents probable causes of questionable unit operation. Refer to Diagnostic Indicator Chart for an interpretation of the signal and to this section for an explanation.

Remove the control box access panel and note the number of diagnostic LED flashes. Refer to Diagnostic Indicator Chart for an interpretation of the signal and to this section for an explanation.

FAULT RECALL

The ignition control is equipped with a momentary push-button switch that can be used to display on the diagnostic LED the last five faults detected by the control. Any time the control is powered, the fault code history can be retrieved for display by depressing and releasing the button once (less than 5 seconds); the LED will flash the Fault Code History (up to 5 fault codes from newest to oldest). The Fault Code History is retained between power cycles until cleared. A fault code is added to the history log as it is encountered if it differs from the most recent history log item. If the history log is already full, then the oldest entry is dropped from the log and the remaining entries are moved down in the Fault Code History so that the new fault can be added to the Fault Code History as the most recent fault.

NOTE: Do not hold for longer than 5 seconds. Holding the button for 5 seconds or higher will erase the memory!

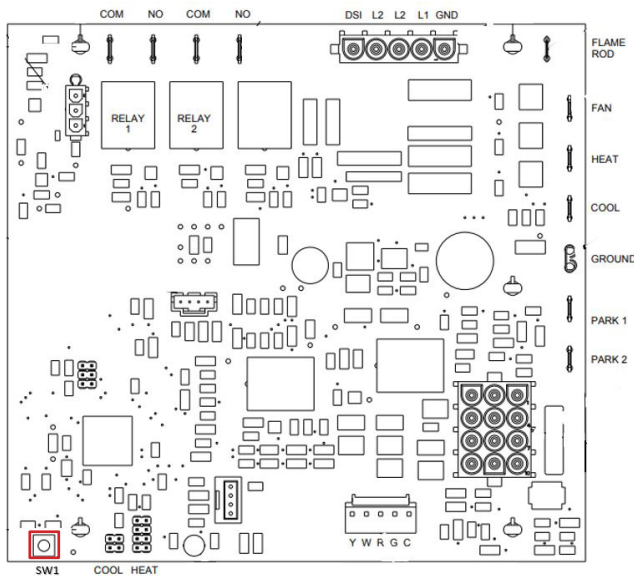

PCBBL216 CONTROL BOARD

RESETTING FROM LOCKOUT

An external lockout occurs if the integrated ignition control determines that a measurable combustion cannot be established within three (3) consecutive ignition attempts. If flame is not established within the four (4) second trial for ignition, the gas valve is de-energized, 30 second inter-purge cycle is completed, and ignition is re-attempted. The control will repeat this routine three times if a measurable combustion is not established. The control will then shut off the induced draft blower and go into a lockout state. If flame is established but lost, the control will energize the circulator blower at the heat speed and then begin a new ignition sequence. If flame is established then lost on subsequent attempts, the control will recycle the ignition sequence.

The diagnostic fault code is 1 flash for a lockout due to failed ignition attempts. The integrated control will automatically reset after one hour, or it can be reset by removing the thermostat signal or disconnecting the electrical power supply for over five seconds.

IMPORTANT NOTE: If you have to frequently reset your gas/electric package unit, it means that a problem exists that should be corrected. Contact a qualified servicer for further information.

PRESSURE SENSOR

The pressure sensor is mounted near induced draft blower. Its function is to regulate the induced draft blower's speed in order to maintain proper air-fuel ratio for clean and reliable combustion. The electrical output signal from the sensor is expected to be proportional to the magnitude of the differential pressure between the inducer inlet negative pressure and the ambient air pressure. The pressure sensor also guards against insufficient airflow (combustion air and flue products) through the heat exchanger. At the beginning of a call for heat, the control ensures the inducer is in an off state, then checks the pressure sensor output for the proper null offset value. If the pressure sensor output is outside the acceptable range for the null value, the control enters a five minute lockout. After the lockout timer has expired, the control resumes normal operation.

During inducer operation, including all operating modes except for the null test, the control monitors the pressure sensor output for expected values. The control limits during normal operation are expected to be within certain tolerances of the target pressures. In response to a pressure sensor span error, the control enters a five minute lockout. After the lockout timer has expired, the control resumes normal operation.

TROUBLESHOOTING

PRIMARY LIMIT

A primary limit will open due to excessive supply air temperatures. This can be caused by a dirty filter, excessive duct static, insufficient air flow, or a faulty limit. Check filters, total external duct static, blower motor, blower motor speed tap (see wiring diagram), and limit. This limit will automatically reset once the temperature falls below a preset level.

If a limit switch opens, the gas valve is immediately de-energized, the induced draft and air circulating blowers are energized. The induced draft and air circulator blowers remain energized for 5 minutes or until the limit switch re-closes, whichever happens first.

NOTE: If the primary limit opens three (3) times within the same call for heat, the ignition control will lock out for one (1) hour with the air circulating blower energized at high heat speed.

FLAME DETECTED WITH GAS VALVE CLOSED

If flame is detected with the gas valve de-energized, the combustion and air circulator blowers are energized. The control can be reset by removing the power supply to the unit or it will automatically reset after one hour. Miswiring is the probable cause for this fault. The initial lockout period is 5 minutes. After that time, the control continues to monitor the flame sense input and resumes normal operation when flame is no longer sensed.

LOW FLAME SIGNAL

Under some conditions, the fuel or air supply can create a nearly invisible coating on the flame sensor. This coating acts as an insulator causing a drop in the flame signal. If the flame signal drops below a predetermined value, the ignition control will display an error code of (1) flash on the amber diagnostic LED. The unit will continue to operate until the control can no longer detect flame.

BURNER TEMPERATURE SWITCH

The burner temperature switch is mounted on the burner box assembly to monitor the burner box temperature. It is normally closed (electrically), auto-reset switch. This switch guards against the burner flames not being properly drawn into the heat exchanger.

The control senses an open blocked burner switch, indicating that the burner temperature/pressure has exceeded its set point. The control de-energizes the gas valve, energizes the inducer to the pre-purge setting and energizes the indoor blower. The initial lockout period is five minutes. After this time elapses, the control evaluates the state of the blocked burner switch. If the switch is closed, the control resumes normal operation. The control will enter a one hour lockout state if the blocked burner switch fails to reset before the recovery timer has expired.

ID PLUG

The control operational parameters are stored in ID Plug which connects on the circuit board. The control requires a valid ID plug present to operate in heating mode. If a valid ID plug is not present the control will not respond to a call for heat. However, the control will respond to thermostat inputs "Y" or "G", operating the appropriate fan output. The cooling delays are ignored in this operating mode. The control puts the burner into hard lockout and will not respond to heating requests until the power is cycled with a valid ID plug installed.

ABNORMAL OPERATION - COOLING

SHORT CYCLE COMPRESSOR DELAY

In the event of intermittent power losses or intermittent thermostat operation, the control system will delay output to the compressor contactor for three minutes from the time power is restored or thermostat call for cooling is restored. (Compressor is off a total of three minutes).



NOTE: Some electronic thermostats also have a built-in compressor short cycle timer that may be longer than the three minute delay given above. If you are using an electronic thermostat and the compressor has not started after three minutes, wait an additional five minutes to allow the thermostat to complete its short cycle delay time.

HIGH PRESSURE SWITCH/LOW PRESSURE SWITCH

Some models include a high pressure cutout switch and/or a low pressure switch. The high pressure cutout switch protects the refrigeration system from excessive operating pressures. The low pressure switch protects the refrigeration system from very low operating pressures due to a loss of refrigerant. Compressor operation will be disabled if either of these devices opens.

MAINTENANCE

MAINTENANCE

 WARNING	
HIGH VOLTAGE! DISCONNECT ALL POWER BEFORE SERVICING OR INSTALLING. MULTIPLE POWER SOURCES MAY BE PRESENT. FAILURE TO DO SO MAY CAUSE PROPERTY DAMAGE, PERSONAL INJURY OR DEATH.	

Have the gas heating section of the unit checked at least once a year before the heating season begins, to be sure that the combustion air inlet and flue outlet hoods are not blocked by debris, which would prevent adequate combustion air and a properly operating vent system.

FILTER REPLACEMENT OR CLEANING

A return air filter is not supplied with this unit; however, there must be a means of filtering all of the return air. The filter(s) may be located in the return air duct(s), or return air filter grille(s). Consult with your installing dealer for the actual location of the return air filter(s) for your unit.

Dirty filters are the most common cause of inadequate heating or cooling performance. Filter inspection should be made at least every two months; more often if necessary because of local conditions and usage.

Dirty throwaway filters should be discarded and replaced with a new, clean filter. Dirty permanent filters should be washed with water, thoroughly dried and sprayed with a filter adhesive before being reinstalled (Filter adhesives may be found at many hardware stores). Permanent filters should last several years. However, should one become torn or uncleanable, it should be replaced.

CABINET FINISH MAINTENANCE

Use a fine grade automotive wax on the cabinet finish to maintain the finish's original high luster. This is especially important in installations with extended periods of direct sunlight.

CLEAN OUTSIDE COIL (QUALIFIED SERVICER ONLY)

The coil with the outside air flowing over it should be inspected annually and cleaned as frequently as necessary to keep the finned areas free of lint, hair and debris.

CONDENSER, EVAPORATOR, AND INDUCED DRAFT MOTORS

Bearings on the air circulating blower motor, condenser motor and the combustion fan motor are permanently lubricated. No additional oiling is required.

FLAME SENSOR (QUALIFIED SERVICER ONLY)

A drop in the flame current can be caused by a nearly invisible coating on the flame sensor. This coating, created by the fuel or combustion air supply, can be removed by carefully cleaning the flame sensor with steel wool.

NOTE: After cleaning, the microamp signal should be stable and in the range of 5-10 microamps DC.

FLUE PASSAGES (QUALIFIED SERVICER ONLY)

At the start of each heating season, inspect and, if necessary, clean the unit flue passage.

CLEANING FLUE PASSAGES (QUALIFIED SERVICER ONLY)

1. Shut off electric power and gas supply to the unit.
2. Remove burner assembly by disconnecting the gas line and removing the manifold bracket from the partition panel.
3. Remove the flue from the induced draft blower and the collector box cover from the partition panel.
4. The primary heat exchanger tubes can be cleaned using a round wire brush attached to a length of high grade stainless steel cable, such as drain cleanout cable. Attach a variable speed reversible drill to the other end of the spring cable. Slowly rotate the cable with the drill and insert it into one of the primary heat exchanger tubes. While reversing the drill, work the cable in and out several times to obtain sufficient cleaning. Use a large cable for the large tube, and then repeat the operation with a small cable for the smaller tube. Repeat for each tube.
5. When all heat exchanger tubes have been cleaned, replace the parts in the reverse order in which they were removed.
6. To reduce the chances of repeated fouling of the heat exchanger, perform the steps listed in "Startup, Adjustments, and Checks".

BURNERS

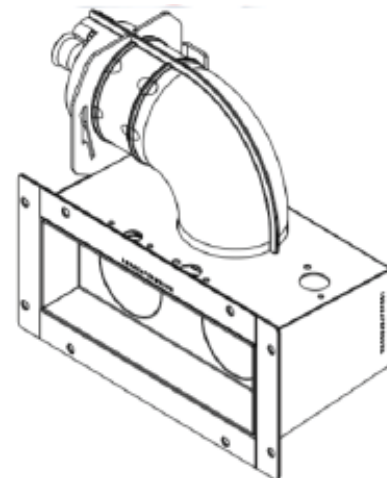

MAINTENANCE



WARNING

TO AVOID PERSONAL INJURY OR DEATH DUE TO ELECTRIC SHOCK, DO NOT REMOVE ANY INTERNAL COMPARTMENT COVERS OR ATTEMPT ANY ADJUSTMENT. CONTACT A QUALIFIED SERVICER AT ONCE IF AN ABNORMAL FLAME SHOULD DEVELOP.

The Ultra low NOx models are equipped with premix burner. The burner box is sealed to achieve safe and reliable operation. The burner box should not have any blockage near the air-gas mixer inlet.



CAUTION

LABEL ALL WIRES PRIOR TO DISCONNECTION WHEN SERVICING CONTROLS. WIRING ERRORS CAN CAUSE IMPROPER AND DANGEROUS OPERATION.



CAUTION

ALWAYS VERIFY PROPER OPERATION AFTER SERVICING.

For further information on the yearly inspection, consult the User Manual. It is recommended that a qualified servicer inspect and service the unit at least once each year.

Turn the unit on at the thermostat. Wait a few minutes, since any dislodged dust will alter the normal flame appearance. Flames should be predominantly blue and directed into the tubes. They should not be yellow. They should extend directly outward from the burner ports without curling downward, floating or lifting off the ports.

WIRING DIAGRAMS



HIGH VOLTAGE!
Disconnect ALL power before servicing or installing this unit. Multiple power sources may be present. Failure to do so may cause property damage, personal injury or death.

WARNING

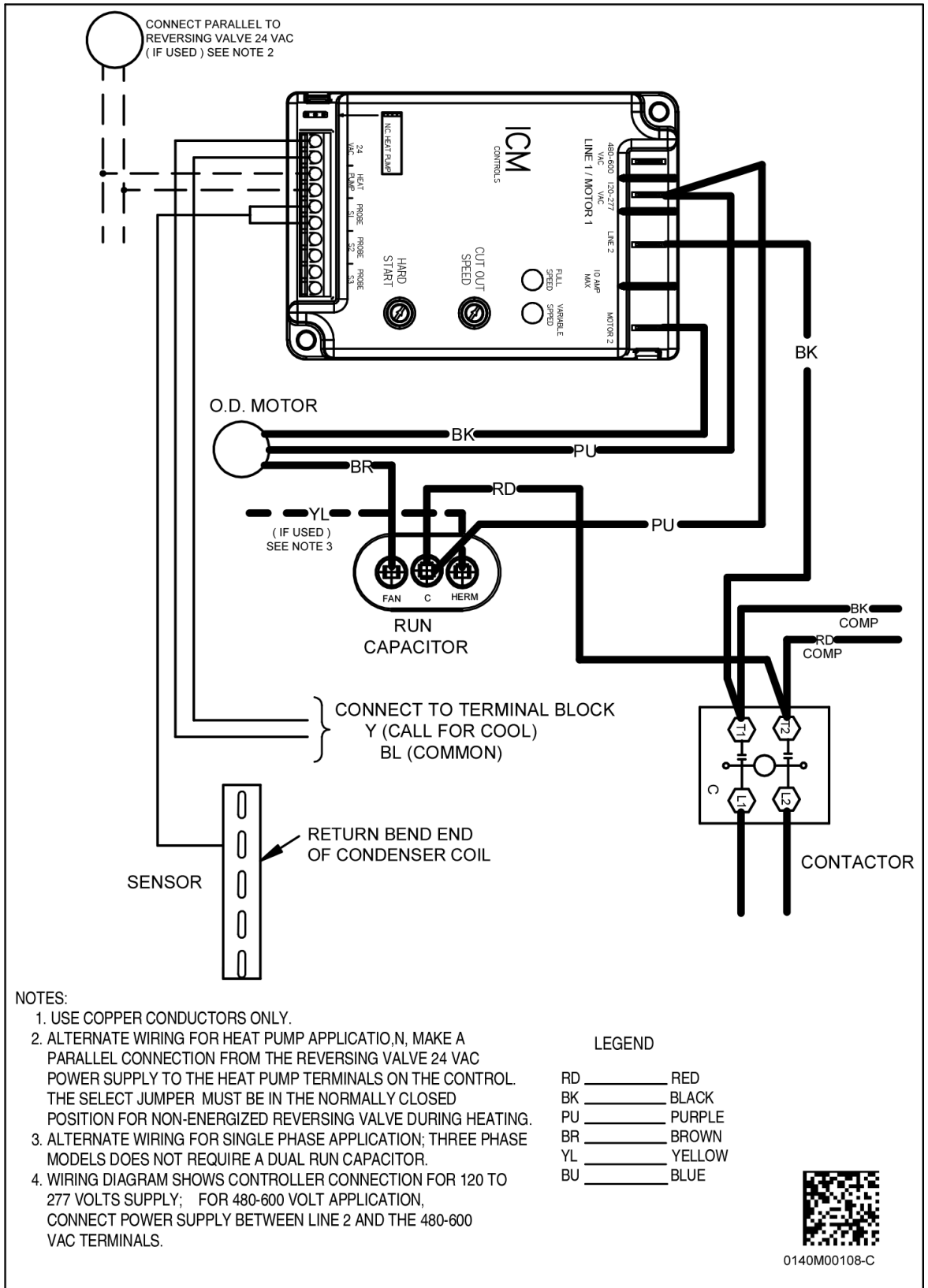

NOTICE: The cutout speed & hard start settings are factory preset. Changing those settings may cause early motor failure.

Wiring is subject to change. Always refer to the wiring diagram on the unit for the most up-to-date wiring.



WARNING

HIGH VOLTAGE!

Disconnect ALL power before servicing or installing this unit. Multiple power sources may be present. Failure to do so may cause property damage, personal injury or death.



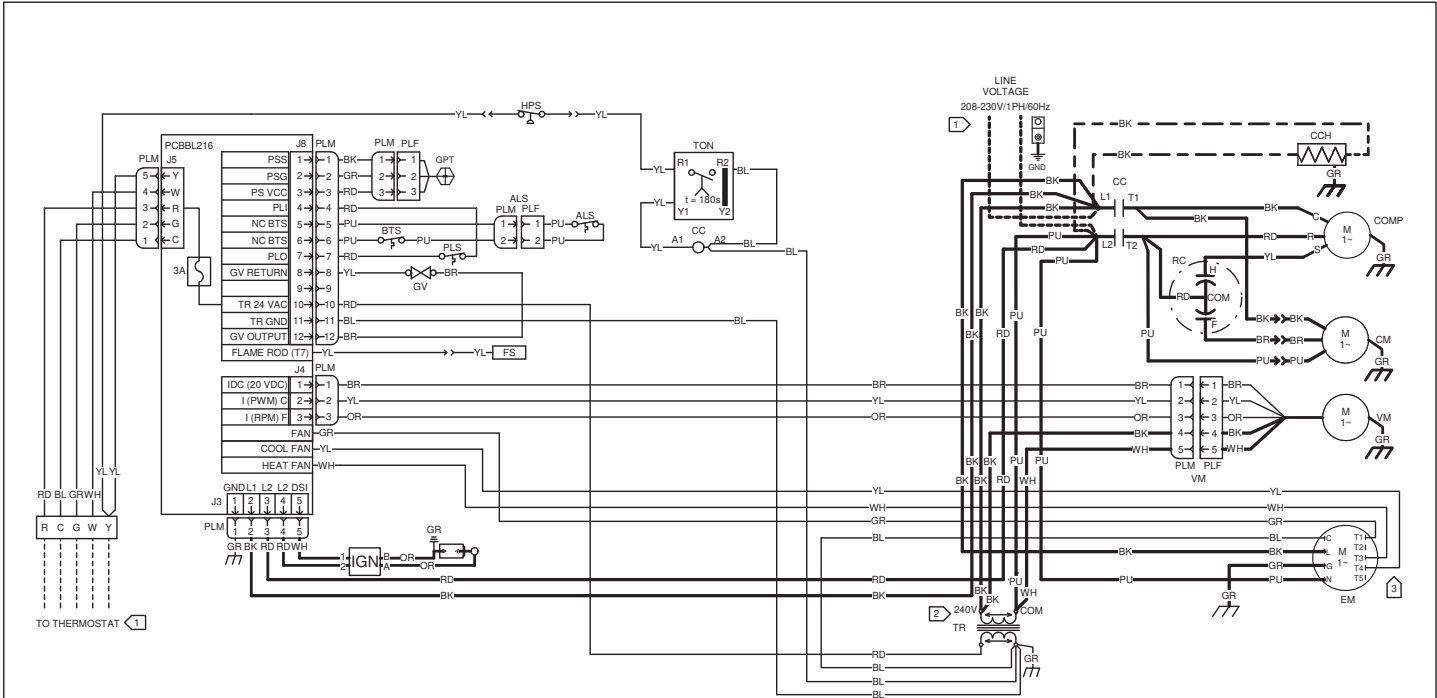

THE STATUS LIGHT ON THE FURNACE CONTROL MAY BE USED AS A GUIDE TO TROUBLESHOOTING THIS APPLIANCE. SOME MORE USEFUL STATUS LIGHT CODES ARE BELOW:

COMPONENT LEGEND		WIRE CODE	
ALS	AUXILIARY LIMIT SWITCH	BK	BLACK
BTS	BURNER TEMPERATURE SWITCH	BL	BLUE
CC	COMPRESSOR CONTACTOR	BR	BROWN
CCH	CRANKCASE HEATER	GR	GREEN
CM	CONDENSER MOTOR	GY	GRAY
COMP	COMPRESSOR	OR	ORANGE
EM	EVAPORATOR MOTOR	PK	PINK
FPS	FREEZE PROTECTION SWITCH	PU	PURPLE
FS	FLAME SENSOR	RD	RED
GND	EQUIPMENT GROUND	TR	TAN
GPT	GAS PRESSURE TRANSDUCER	WH	WHITE
GV	GAS VALVE	YL	YELLOW
HPS	HIGH PRESSURE SWITCH		
IGN	IGNITOR		
PLF	FEMALE PLUG/CONNECTOR		
PLM	MALE PLUG/CONNECTOR		
PLS	PRIMARY LIMIT SWITCH		
RC	RUN CAPACITOR		
TON	ON-DELAY TIMER RELAY		
TR	TRANSFORMER		
VM	VENT MOTOR		

- NOTES**
- REPLACEMENT WIRE MUST BE SAME SIZE AND TYPE OF INSULATION AS ORIGINAL (AT LEAST 105° C). USE COPPER CONDUCTORS ONLY. USE N.E.C. CLASS 2 WIRE FOR ALL LOW VOLTAGE FIELD CONNECTIONS. USE COPPER CONDUCTORS FOR UNIT SUPPLY POWER.
 - FOR 208V SUPPLY POWER, MOVE WIRES FROM THE 240V TAP TO THE 208V TAP.
 - TO CHANGE COOLING SPEED, MOVE YL WIRE TO EITHER THE T4 (LOW COOL) OR T5 (HIGH COOL) SPEED TAP. TO CHANGE THE HEATING SPEED, MOVE WH WIRE TO EITHER THE T2 (LOW HEAT) OR T3 (HIGH HEAT) SPEED TAPS.

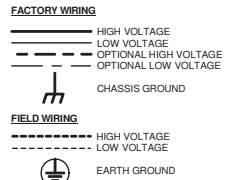

PCBBL216 LUM CONTROL ERROR CODES											
LED ACTIVITY	DESCRIPTION	COLOR	MINIMUM LOCKOUT PERIOD ¹	LED ACTIVITY	DESCRIPTION	COLOR	MINIMUM LOCKOUT PERIOD ¹	LED ACTIVITY	DESCRIPTION	COLOR	MINIMUM LOCKOUT PERIOD ¹
LED OFF	NO 24 VAC POWER TO CONTROL	—	N/A	6 FLASHES	NORMALLY CLOSED BLOCKED BURNER SWITCH/AUXILIARY SWITCH OPEN	RED	MAXIMUM RECOVERY TIME - 1 HOUR IF TIME EXCEEDED	2 FLASHES	ID PLUG FAILURE	AMBER	HARD LOCKOUT HEATING MODE
RED, AMBER, GREEN	POWER-UP VERIFICATION OF LED	—	N/A	7 FLASHES	GAS VALVE CIRCUIT SHORTED	RED	1 HOUR	3 FLASHES	CONTROL FUSE OPEN	AMBER	5 MINUTES
STEADY ON	CONTROL FAULT DETECTED	RED	1 HOUR OR HARD LOCKOUT	8 FLASHES	RESERVED	RED	—	STEADY ON	STANDBY NORMAL OPERATION NO THERMOSTAT REQUESTS	GREEN	N/A
1 FLASH	RETRIES EXCEEDED	RED	1 HOUR FIXED	10 FLASHES	HIGH LIMIT SWITCH RECOVERY TIMER EXPIRED	RED	1 HOUR OR HARD LOCKOUT	RAPID FLASH	CLEAR ERROR HISTORY	GREEN	N/A
2 FLASHES	PRESSURE SENSOR NULL ERROR	RED	5 MINUTES	STEADY ON	DEM FACTORY TEST MODE	AMBER	N/A	1 FLASH	CALL FOR HEATING	GREEN	N/A
3 FLASHES	PRESSURE SENSOR SPAN ERROR	RED	5 MINUTES	RAPID FLASH	FIELD TEST MODE	AMBER	N/A	2 FLASHES	CALL FOR COOLING	GREEN	N/A
4 FLASHES	HIGH LIMIT SWITCH OPEN	RED	MAXIMUM RECOVERY TIME - 1 HOUR AFTER MAX TRIPS EXCEEDED	1 FLASH	LOW FLAME SENSE	AMBER	N/A	3 FLASHES	CONTINUOUS FAN OPERATION	GREEN	N/A
5 FLASHES	FLAME PRESENT WITH GAS VALVE OFF	RED	5 MINUTES	—	—	—	—	—	—	—	—

¹ THE FAULT CONDITION MUST BE CLEARED FOR 30 SECONDS BEFORE NORMAL OPERATION CAN RESUME. A POWER CYCLE WILL ALSO RESET ANY LOCKOUT.



Wiring is subject to change. Always refer to the wiring diagram on the unit for the most up-to-date wiring.

WIRING DIAGRAMS

*PUM3(61)***41**



WARNING

HIGH VOLTAGE!

Disconnect ALL power before servicing or installing this unit. Multiple power sources may be present. Failure to do so may cause property damage, personal injury or death.



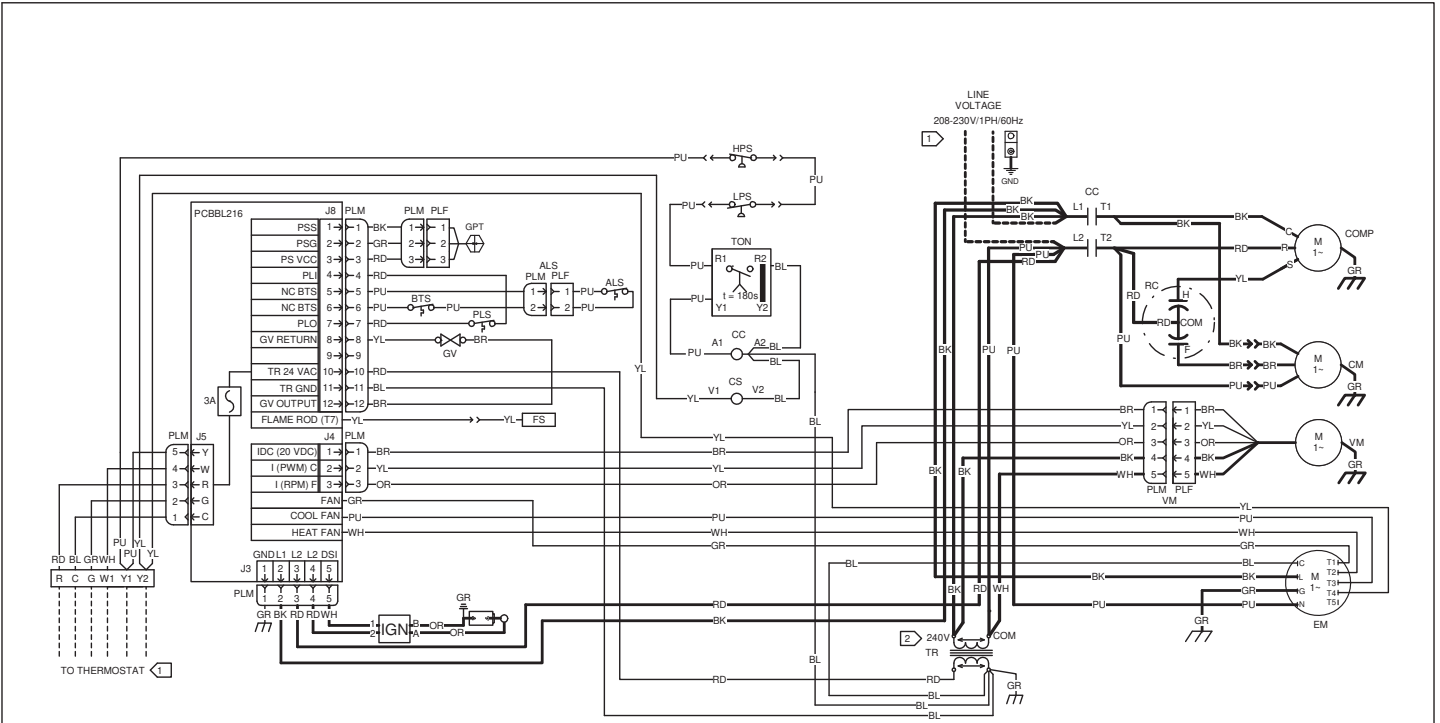

- COMPONENT LEGEND**
- | | | | | | |
|------|---------------------------------|-----|------------------------|----|--------|
| ALS | AUXILIARY LIMIT SWITCH | GV | GAS VALVE | BK | BLACK |
| BTS | BURNER TEMPERATURE SWITCH | HPS | HIGH PRESSURE SWITCH | BL | BLUE |
| CC | COMPRESSOR CONTACTOR | IGN | IGNITOR | BR | BROWN |
| CCH | CRANKCASE HEATER | LPS | LOW PRESSURE SWITCH | GR | GREEN |
| CM | CONDENSER MOTOR | PLF | FEMALE PLUG/CONNECTOR | GY | GRAY |
| COMP | COMPRESSOR | PLM | MALE PLUG/CONNECTOR | OR | ORANGE |
| CS | COMP SOLENOID (2ND STG COOLING) | PLS | PRIMARY LIMIT SWITCH | PK | PINK |
| EM | EVAPORATOR MOTOR | RC | RUN CAPACITOR | PU | PURPLE |
| FPS | FREEZE PROTECTION SWITCH | TON | ON - DELAY TIMER RELAY | RD | RED |
| FS | FLAME SENSOR | TR | TRANSFORMER | TN | TAN |
| GND | EQUIPMENT GROUND | VM | VENT MOTOR | WH | WHITE |
| GPT | GAS PRESSURE TRANSDUCER | | | YL | YELLOW |

- NOTES**
- REPLACEMENT WIRE MUST BE SAME SIZE AND TYPE OF INSULATION AS ORIGINAL (AT LEAST 105° C). USE COPPER CONDUCTORS ONLY. USE N.E.C. CLASS 2 WIRE FOR ALL LOW VOLTAGE FIELD CONNECTIONS. USE COPPER CONDUCTORS FOR UNIT SUPPLY POWER.
 - FOR 208V SUPPLY POWER, MOVE WIRES FROM THE 240V TAP TO THE 208V TAP.
- FACTORY WIRING**
- Solid line: HIGH VOLTAGE
 - Dashed line: LOW VOLTAGE
 - Line with diagonal hatching: OPTIONAL HIGH VOLTAGE
 - Line with horizontal hatching: OPTIONAL LOW VOLTAGE
- FIELD WIRING**
- Solid line: HIGH VOLTAGE
 - Dashed line: LOW VOLTAGE
- CHASSIS GROUND** (Symbol: ⏏)
- EARTH GROUND** (Symbol: ⊕)

THE STATUS LIGHT ON THE FURNACE CONTROL MAY BE USED AS A GUIDE TO TROUBLESHOOTING THIS APPLIANCE. SOME MORE USEFUL STATUS LIGHT CODES ARE BELOW:

PCBLL216 ULN CONTROL ERROR CODES											
LED ACTIVITY	DESCRIPTION	COLOR	MINIMUM LOCKOUT PERIOD ¹	LED ACTIVITY	DESCRIPTION	COLOR	MINIMUM LOCKOUT PERIOD ¹	LED ACTIVITY	DESCRIPTION	MINIMUM LOCKOUT PERIOD ¹	
LED OFF	NO 24 VAC POWER TO CONTROL	---	N/A	6 FLASHES	NORMALLY CLOSED BURNER SWITCH/AUXILIARY SWITCH OPEN	RED	MAXIMUM RECOVERY TIME - 1 HOUR IF TIME EXCEEDED	2 FLASHES	ID PLUG FAILURE	HARD LOCKOUT HEATING MODE	
RED, AMBER, GREEN	POWER-UP VERIFICATION OF LED	---	N/A	7 FLASHES	GAS VALVE CIRCUIT SHORTED	RED	1 HOUR	3 FLASHES	CONTROL FUSE OPEN	AMBER	5 MINUTES
STEADY ON	CONTROL FAULT DETECTED	RED	1 HOUR OR HARD LOCKOUT	8 FLASHES	RESERVED	RED	---	STEADY ON	STANDBY NORMAL OPERATION NO THERMOSTAT REQUESTS	GREEN	N/A
1 FLASH	RETRIES EXCEEDED	RED	1 HOUR FIXED	10 FLASHES	HIGH LIMIT SWITCH RECOVERY TIMER EXPIRED	RED	1 HOUR OR HARD LOCKOUT	RAPID FLASH	CLEAR ERROR HISTORY	GREEN	N/A
2 FLASHES	PRESSURE SENSOR NULL ERROR	RED	5 MINUTES	STEADY ON	DEM FACTORY TEST MODE	AMBER	N/A	1 FLASH	CALL FOR HEATING	GREEN	N/A
3 FLASHES	PRESSURE SENSOR SPAN ERROR	RED	5 MINUTES	RAPID FLASH	FIELD TEST MODE	AMBER	N/A	2 FLASHES	CALL FOR COOLING	GREEN	N/A
4 FLASHES	HIGH LIMIT SWITCH OPEN	RED	MAXIMUM RECOVERY TIME - 1 HOUR AFTER MAX TRIPS EXCEEDED	1 FLASH	LOW FLAME SENSE	AMBER	N/A	3 FLASHES	CONTINUOUS FAN OPERATION	GREEN	N/A
5 FLASHES	FLAME PRESENT WITH GAS VALVE OFF	RED	5 MINUTES	---	---	---	---	---	---	---	---

¹ THE FAULT CONDITION MUST BE CLEARED FOR 30 SECONDS BEFORE NORMAL OPERATION CAN RESUME. A POWER CYCLE WILL ALSO RESET ANY LOCKOUT.



Wiring is subject to change. Always refer to the wiring diagram on the unit for the most up-to-date wiring.

CUSTOMER FEEDBACK

We are very interested in all product comments.

Please fill out the feedback form on one of the following links:

Goodman® Brand Products: (<http://www.goodmanmfg.com/about/contact-us>).

Amana® Brand Products: (<http://www.amana-hac.com/about-us/contact-us>).

You can also scan the QR code on the right for the product brand you purchased to be directed to the feedback page.



GOODMAN® BRAND



AMANA® BRAND