



Date:

Specification Sheet for Daikin Medium Cabinet 7.5 to 12.5 Ton  
Knocked down 24" Tall Roof Curb

Part Number:  
Daikin PN: 0270L01154  
MicroMetl PN: CRBK-DKN34SA-2411

Submitted To:

Job:

Notes:

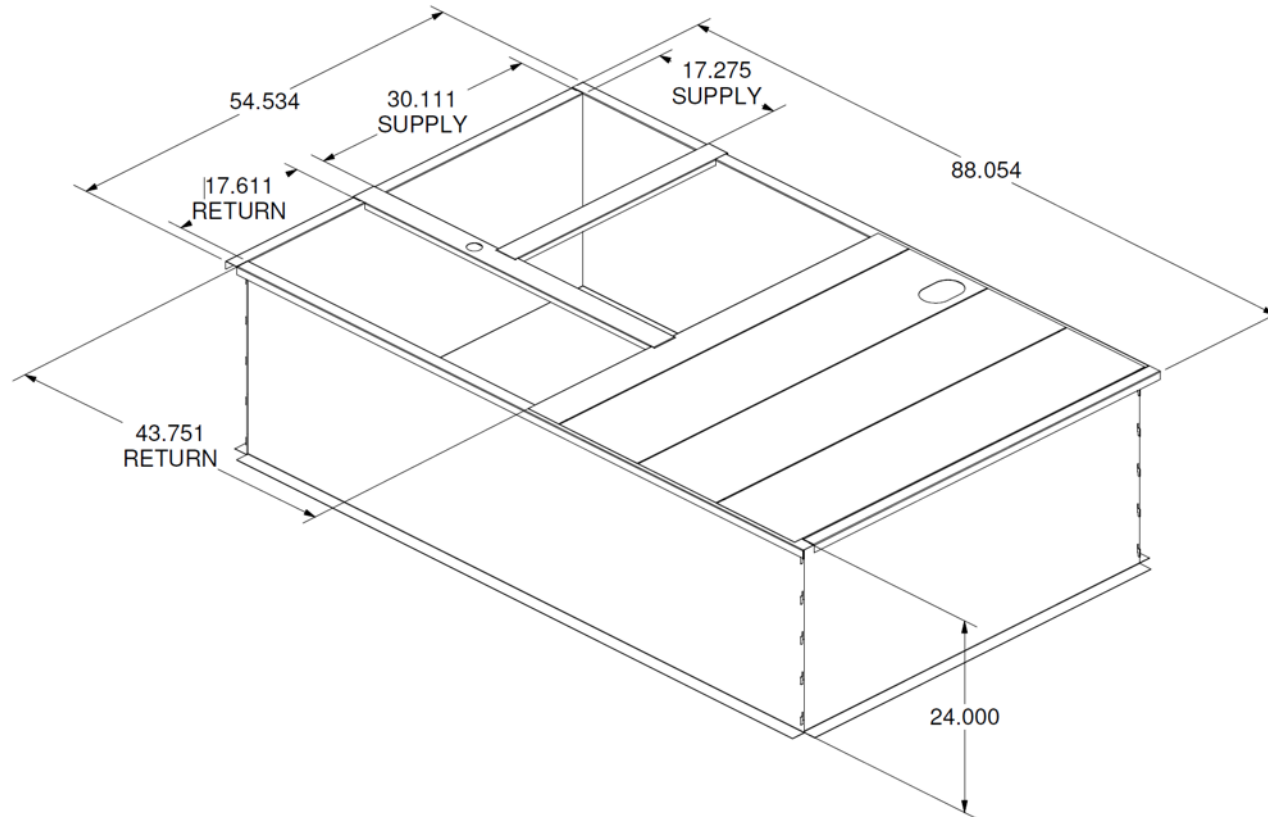

**Notes:**

1. Roof curb ships knocked down for field assembly. Package includes plastic corrugated end caps.
2. Curb includes wood nailer, attached to curb sides and ends, and gasket package shipped inside of curb package.
3. Deck pans include 1" – 1.5 lb. density insulation.
4. Curb sides and ends are constructed of 18 gauge galvanized steel.

**Product Operating Weight:**

**174 Lbs**

The Information contained in this drawing is the sole property of MicroMetl Corporation. Any reproduction in part or whole without the written permission of MicroMetl Corporation is prohibited.